

Home Audio System
MHC-V73D

The following explains how to use this system. Select a topic from the navigation pane.

This Help Guide mainly explains operations using the remote control, but the same operations can also be performed using the controls on the system having the same or similar names.

Getting Started

Parts and controls

- [Main unit](#)

- [Remote control](#)

- [Playable discs or files on discs/USB device](#)

- [Carrying the system](#)

Power source

- [Connecting the system to an AC outlet](#)

- [Inserting batteries to the remote control](#)

- [Turning the power on](#)

- [Turning the power off \(Standby mode\)](#)

[Auto Standby function](#)

[Hooking up TV](#)

Quick Setup

[Performing Quick Setup](#)

[Using the mic holder\(s\)](#)

Demo mode

[Turning off the demonstration mode](#)

TV & Audio device connection

TV

[Hooking up TV](#)

[Using the Control for HDMI function](#)

External audio device

[Listening to music of an external audio device, etc.](#)

Audio device connection

External audio device

[Listening to music of an external audio device, etc.](#)

Disc

Playing a disc

[Playing a disc](#)

[Various disc playback operations](#)

[Using play mode](#)

[Viewing information of a disc](#)

[Restricting playback of the disc \(Parental Control\)](#)

USB device

[Connecting with a USB device](#)

Playing a USB device

[Playing a USB device](#)

[Using play mode](#)

[Viewing information of a USB device](#)

Transferring music to USB device

- [Transferring music from a disc](#)
- [Erasing audio files or folders on the USB device](#)

BLUETOOTH® device

Connecting with BLUETOOTH device

- [Pairing and connecting with BLUETOOTH devices](#)
- [Connecting with an NFC-compatible device by One-touch \(NFC\)](#)
- [Connecting this system with multiple BLUETOOTH devices \(Multi-device connection\)](#)

Listening to music from BLUETOOTH device

- [Listening to music of a device via BLUETOOTH connection](#)
- [Selecting the BLUETOOTH audio streaming playback quality \(Codec\)](#)
- [Terminating the BLUETOOTH connection \(After use\)](#)

Other operations

- [Turning on or off the BLUETOOTH signal](#)
- [Using the BLUETOOTH standby function](#)

Radio

Listening to FM radio

- [Listening to FM radio](#)
- [Presetting radio stations](#)

Connecting Multiple System for Playback

Wireless Party Chain function

- [Enjoying wireless playback using multiple audio systems \(Wireless Party Chain function\)](#)
- [Terminating the Wireless Party Chain function](#)

Stereo Pair function

- [Listening to music wirelessly with two systems \(Stereo Pair function\)](#)

Adjusting the sound

[Reinforcing bass sound and creating more powerful sound \(MEGA BASS\)](#)

[Selecting a sound field](#)

Using dedicated apps

Using "Sony | Music Center"

[What you can do with "Sony | Music Center"](#)

[Installing "Sony | Music Center"](#)

Using "Fiestable"

[What you can do with "Fiestable"](#)

[Installing "Fiestable"](#)

[Using the DJ Effect and sampler](#)

[Personalizing your own lighting](#)

[Achieving and sharing a Party People ranking and getting bonus features \(Party King\)](#)

[Using Voice Control via "Fiestable"](#)

[Creating party lighting atmosphere via "Fiestable"](#)

[Singing and competing in Karaoke \(Karaoke Ranking\)](#)

[Creating playlist from multiple BLUETOOTH devices \(Party Playlist\)](#)

[Competing in the Taiko game \(Taiko Game Ranking\)](#)

Using Gesture Control

[Controlling the operations using Gesture Control](#)

[Using Gesture Control to operate playback, DJ Effect, sampler, and karaoke \(GESTURE 1\)](#)

[Using Gesture Control to control the key of your voice or music source \(GESTURE 2\)](#)

[Deactivating the controls on the system for a short time \(Party Lock\)](#)

Singing along: Karaoke

[Singing karaoke](#)

[Various functions for karaoke](#)

[Enjoying sound from a guitar](#)

Other Operations

[Playing the drum \(Taiko\)](#)

[Using the Sleep Timer](#)

[Enjoying music with the lighting \(Party Light/Speaker Light\)](#)

[Using the Voice Guidance](#)

[Deactivating the controls on the system \(Child Lock\)](#)

[Listening to the built-in sound demonstration](#)

[Settings menu](#)

Information

[About the indicators](#)

[Updating the pre-installed software](#)

[Parental Control area code list](#)

[Language code list](#)

Troubleshooting

What can I do to solve a problem?

[What can I do to solve a problem?](#)

[About Self-diagnosis function](#)

[About messages](#)

General

[The power does not turn on.](#)

[The system has entered standby mode.](#)

[There is no sound.](#)

[There is severe hum or noise.](#)

[The remote control does not function.](#)

[The color irregularity on a TV screen persists.](#)

[\[CHILD LOCK\] appears when you use any control on the system.](#)

[A clicking sound is heard when the system is turned on.](#)

Control for HDMI function ("BRAVIA")

[The system does not turn on even when the TV is turned on.](#)

[The system turns off when the TV is turned off.](#)

[The system does not turn off even when the TV is turned off.](#)

[There is no picture/sound when connected to the HDMI OUT \(TV\) ARC connector.](#)

[No TV sound is output from the system.](#)

[No TV sound is heard from the system. \[CODE 01\] and \[SGNL ERR\] appear on the display.](#)

[The sound is output from both the system and the TV.](#)

[The Control for HDMI function does not work properly.](#)

Disc

[The disc tray does not open and \[LOCKED\] appears on the display.](#)

[The disc tray does not close.](#)

[The disc does not eject.](#)

[Playback does not start.](#)

[The sound skips during disc playback.](#)

[Playback does not start from the first track/file.](#)

[You cannot perform some functions such as Stop, Lock Search, Slow-motion Play, Repeat Play, or Shuffle Play.](#)

[Files cannot be played back.](#)

[The name does not appear properly.](#)

[\[READING\] is displayed for an extended time, or it takes a long time before playback starts.](#)

[There is no picture.](#)

[Picture noise appears.](#)

[The aspect ratio of the TV screen cannot be changed.](#)

[The language for sound track, subtitles, or camera angles cannot be changed.](#)

[The subtitles cannot be turned off.](#)

USB

[Playback does not start.](#)

[Playback does not start from the first file.](#)

[Files cannot be played back.](#)

[The name does not appear properly.](#)

[There is no sound during USB playback.](#)

[There is noise, skipping, or distorted sound during USB playback.](#)

[\[READING\] is displayed for an extended time, or it takes a long time before playback starts.](#)

[\[NO FILE\] appears on the display.](#)

[\[OVER CURRENT\] appears on the display.](#)

[The USB device is not recognized.](#)

[Transferring results in an error.](#)

[Audio files or folders on the USB device cannot be erased.](#)

BLUETOOTH device

- [Pairing cannot be performed.](#)
- [The BLUETOOTH device cannot detect the system, or \[BT OFF\] appears on the display.](#)
- [Connection is not possible.](#)
- [iPhone/iPod cannot be connected with the system.](#)
- [The sound skips or fluctuates, or the connection is lost.](#)
- [The sound of your BLUETOOTH device cannot be heard on this system.](#)
- [There is severe hum, noise, or distorted sound.](#)

Radio

- [There is severe hum or noise, or stations cannot be received.](#)
- [The stereo FM reception is noisy.](#)

Multiple System for Playback

- [The BLUETOOTH device cannot be connected to the system during Wireless Party Chain function.](#)
- [The BLUETOOTH device cannot be connected to the system during Stereo Pair function.](#)

Dedicated apps

- [Voice Control does not work properly.](#)

Gesture Control

- [The Gesture Control cannot be activated.](#)
- [The Gesture Control does not operate properly.](#)

Karaoke

- [There is no microphone sound.](#)
- [There is acoustic feedback.](#)
- [The sound loses stereo effect during playback.](#)

Reset

- [The system does not operate properly.](#)
- [Returning the setup menu settings to the default](#)

Main unit

Front

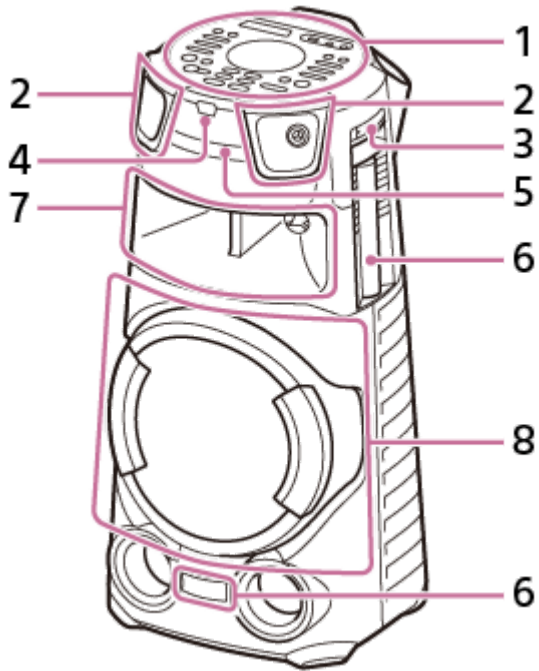

1. Top panel
2. Tweeter R/L front
3. Mic holder
4. Remote control sensor ()
5. Disc tray
6. Party Light*
7. Midrange speaker (The lighting function equipped*)
8. Subwoofer (The lighting function equipped*)

* Do not look directly at the light-emitting part when the lighting is turned on.

Rear

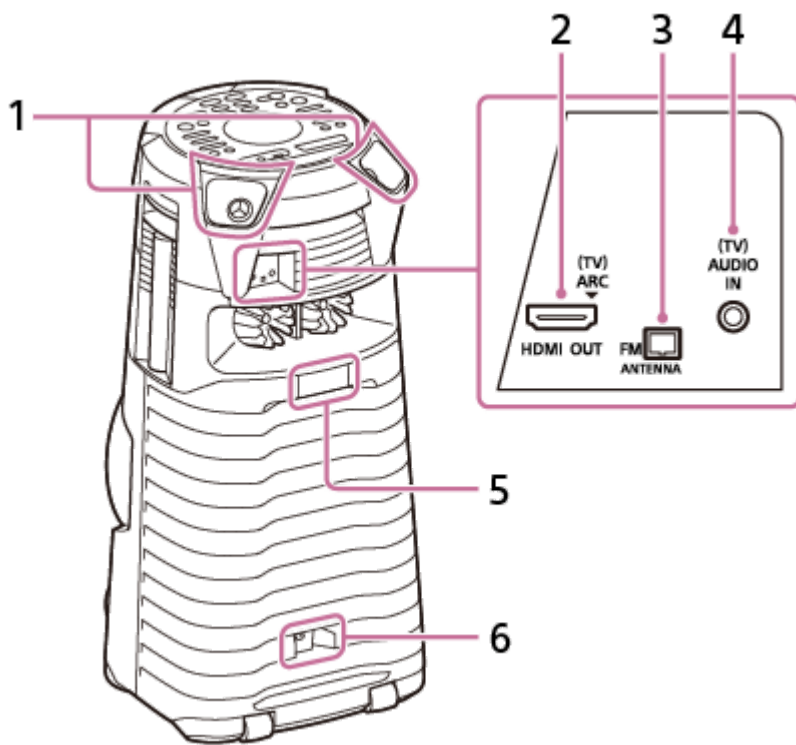

1. Tweeter R/L rear
2. HDMI OUT (TV) ARC connector
3. FM ANTENNA terminal
4. (TV) AUDIO IN jack
5. Party Light*
6. AC IN jack

* Do not look directly at the light-emitting part when the lighting is turned on.

Top panel

You can deactivate the controls (except  (power)) on the system to prevent misoperation by children.

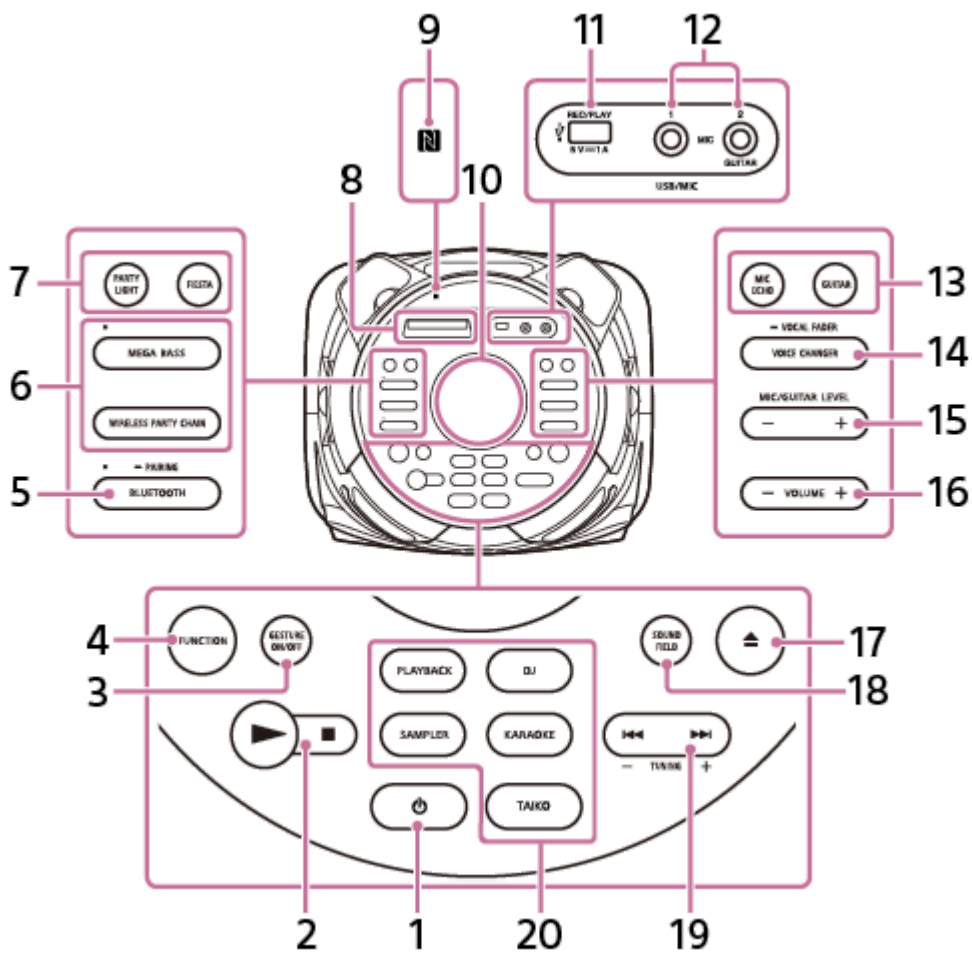

1. (power)
Press to turn on the system, or set it to standby mode.
2. (play)
 (stop)
3. GESTURE ON/OFF
4. FUNCTION
5. BLUETOOTH/ PAIRING with indicator
6. MEGA BASS with indicator
WIRELESS PARTY CHAIN
7. PARTY LIGHT
FIESTA
8. Display
9. (N-Mark)
10. GESTURE CONTROL sensor
11. (USB) REC/PLAY port
12. MIC1 jack
MIC2/GUITAR jack
13. MIC ECHO
GUITAR

14. VOICE CHANGER/  VOCAL FADER

15. MIC/GUITAR LEVEL -/+

16. VOLUME -/+

Adjust the volume.

17.  (open/close)

18. SOUND FIELD

19.  (previous)/  (next)

TUNING -/+

20. PLAYBACK

DJ

SAMPLER

KARAOKE

TAIKO

Related Topic

- [About the indicators](#)
- [Deactivating the controls on the system \(Child Lock\)](#)
- [Using the mic holder\(s\)](#)

5-014-121-11(2) Copyright 2020 Sony Corporation

Remote control

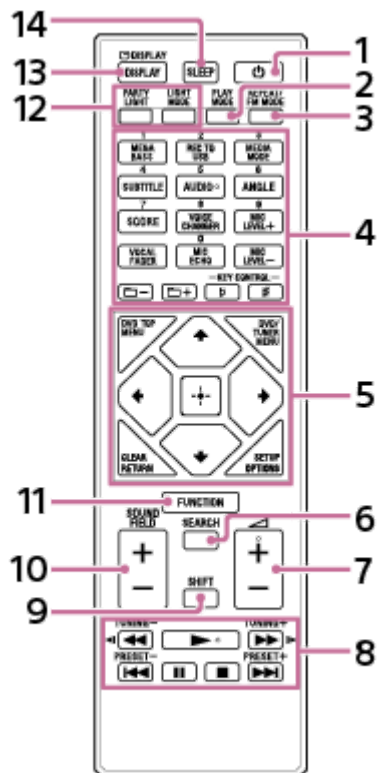

1. (power)
2. PLAY MODE
3. REPEAT/FM MODE
4. Numeric (0 – 9)^{*1} ^{*2}
 MEGA BASS
 REC TO USB
 MEDIA MODE
 SUBTITLE
 AUDIO^{*2}
 ANGLE
 SCORE
 VOICE CHANGER
 MIC LEVEL +/-
 VOCAL FADER
 MIC ECHO
 (folder) -/+
 KEY CONTROL **b** (flat)/ **#** (sharp)
5. DVD TOP MENU
 DVD/TUNER MENU
 CLEAR^{*1}
 RETURN
 SETUP^{*1}

OPTIONS

▲ (up)/ ▼ (down)/ ◀ (left)/ ▶ (right)

⏏ (enter)

6. SEARCH

7. 🔊 (volume) +/-*2

8. ◀◀ (fast reverse)/ ▶▶ (fast forward)

◀◀ (slow back)/ ▶▶ (slow forward)

TUNING -/+

▶ (play)*2

◀◀ (previous)/ ▶▶ (next)

PRESET -/+

⏏ (pause)

■ (stop)

9. SHIFT*1

10. SOUND FIELD +/-

11. FUNCTION

12. PARTY LIGHT

LIGHT MODE

13. 🗨️ DISPLAY*1

DISPLAY

14. SLEEP

*1 This button is printed in pink. To use this button, hold down SHIFT (9) and press this button.

*2 The numeric button 5/AUDIO, 🔊 (volume) + and ▶ (play) have a tactile dot. Use the tactile dot as a reference when operating the system.

Home Audio System
MHC-V73D

Playable discs or files on discs/USB device

The system supports the following formats of files and discs.

Playable discs

- DVD VIDEO
- DVD-R/-RW in DVD VIDEO format or video mode
- DVD+R/+RW in DVD VIDEO format
- VIDEO CD (Ver. 1.0, 1.1, and 2.0 discs)
- Super VCD
- CD-R/-RW/-ROM in VIDEO CD format or super VCD format
- AUDIO CD
- CD-R/-RW in AUDIO CD format
- CD-R/-RW/-ROM in DATA CD^{*1} format that contains the MP3 files (.mp3)^{*2*3}, MPEG4 files (.mp4/.m4v)^{*3*4}, Xvid files (.avi) and conforms to ISO 9660^{*5} Level 1/Level 2 or Joliet (extended format).
- DVD-R/-RW/-ROM/+R/+RW in DATA DVD^{*1} format that contains the MP3 files (.mp3)^{*2*3}, MPEG4 files (.mp4/.m4v)^{*3*4*6}, Xvid files (.avi)^{*6*7} and conforms to UDF (Universal Disk Format).

Playable files on USB device

- Music:
MP3 files (.mp3)^{*2*3}, WMA files (.wma)^{*3*8}, AAC files (.m4a/.mp4/.3gp)^{*3*9}, WAV files (.wav)^{*3}
- Video:
MPEG4 files (.mp4/.m4v)^{*3*4*6}, Xvid files (.avi)^{*6*7}

*1 DATA CD/DATA DVD that is created in Packet Write format or which has not been correctly finalized cannot be played back.

*2 MP3 (MPEG 1 Audio Layer 3) is a standard format defined by ISO/MPEG for compressed audio data. MP3 files must be in MPEG 1 Audio Layer 3 format. The MP3 PRO audio file can be played back as MP3 file.

*3 Files with copyright protection (Digital Rights Management) cannot be played back by the system.

*4 MPEG4 files must be recorded in MP4 file format. Supported video codec and audio codec are as follows:

- Video codec: MPEG4 Simple Profile (AVC is not supported.)

- Audio codec: AAC-LC (HE-AAC is not supported.)

*5 A logical format of files and folders on CD-ROMs, defined by ISO (International Organization for Standardization).

*6 Video files which is larger than 720 (width) x 576 (height) pixels or with a high width to length ratio cannot be played back.

*7 Xvid files that are longer than 2 hours or the file has been combined from two or more Xvid files may not be played back.

*8 WMA file in WMA DRM, WMA Lossless, or WMA PRO format cannot be played back.

*9 AAC file in AAC DRM and AAC Lossless format or which is encoded at 96 kHz cannot be played back.

Note

- The system will attempt to play back any data with the extensions above, even if it is not in the supported format. Playing this data may generate a loud noise which could damage your speaker system.
- You cannot play back the following discs/files:

- CPRM (Content Protection for Recordable Media) compatible DVD-R/-RW recorded in Copy-Once programs
- A disc that has a non-standard shape (e.g., heart, square, star)
- A disc that has adhesive tape, paper, or a sticker attached to it
- Files that are encrypted or protected by passwords.

Notes on CD-R/-RW and DVD-R/-RW/+R/+RW

- In some cases, a CD-R/-RW and DVD-R/-RW/+R/+RW cannot be played back on this system due to the recording quality or physical condition of the disc, or the characteristics of the recording device and authoring software. For more information, refer to the operating instructions of the recording device.
- Some playback functions may not work with some DVD+Rs/+RWs, even if they have been correctly finalized. In this case, view the disc by normal playback.

Notes on discs

- This product is designed to play back discs that conform to the Compact Disc (CD) standard.
- DualDisc and some music discs encoded with copyright protection technologies do not conform to the CD standard. Therefore, these discs may not be compatible with this product.

Note on multisession disc

This system can play back continuous sessions on a disc when they are recorded in the same format as the first session. However, the playback is not guaranteed.

Note on DVD VIDEO and VIDEO CD playback operations

Some playback operations for a DVD VIDEO or VIDEO CD may be intentionally restricted by software producers. Therefore, some playback features may not be available. Be sure to read the operating instructions of the DVD VIDEO or VIDEO CD.

Notes on playable files

- Playback may take a longer time to start when:
 - a DATA CD/DATA DVD/USB device is recorded with a complicated tree structure.
 - the audio files or video files in another folder have just been played back.
 - many folders or files on the USB device.
- The system can play back a DATA CD/DATA DVD or a USB device in the following conditions:
 - Up to a depth of 8 folders
 - Up to 300 folders
 - Up to 999 files in a disc
 - Up to 2,000 files in a USB device
 - Up to 650 files in a folder

These numbers may vary depending on the file or folder configuration.

- Folders that have no audio files or video files are skipped.

- Files transferred by a device such as a computer may not be played back in the order in which they were transferred.
- The playback order may not be applicable depending on the software used for creating the audio file or video file.
- Compatibility with all encoding/writing software of the supported formats, recording devices, and recording media cannot be guaranteed.
- Depending on the Xvid file, the picture may be unclear or the sound may skip.

Notes about USB devices

- This system is not guaranteed to operate with all USB devices.
- Do not connect the system and the USB device through a USB hub.
- With some connected USB devices, there may be a delay before an operation is performed by this system.
- The playback order for the system may differ from the playback order of the connected USB device.
- Before using a USB device, make sure that no virus-ridden files are on the USB device.

5-014-121-11(2) Copyright 2020 Sony Corporation

Home Audio System
MHC-V73D

Carrying the system

The system has caster wheels so that you can roll it easily.

The caster wheels can be used only on flat surfaces. Lift the system by two people on uneven surfaces using the handles on the system. Correct hand placement while carrying the system is very important to avoid personal injury and/or property damage.

Before carrying the system, disconnect all the cables.

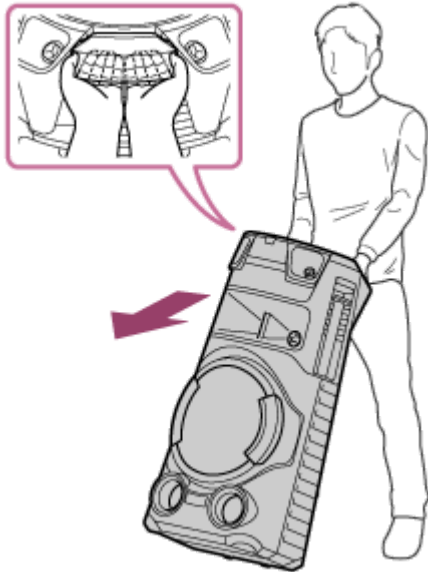

Note

- Exercise extreme caution when carrying the system on a slope.
- Do not carry the system with a person, luggage, etc. on it.
- Do not let children or infants be near when carrying the system.
- Do not use the mic holder to carry the system.
- Fold the mic holder before carrying the system.

Connecting the system to an AC outlet

- 1 Firmly insert the end of the AC power cord (mains lead) (supplied) to the AC IN jack on the rear of the system, and then to an AC outlet (①).

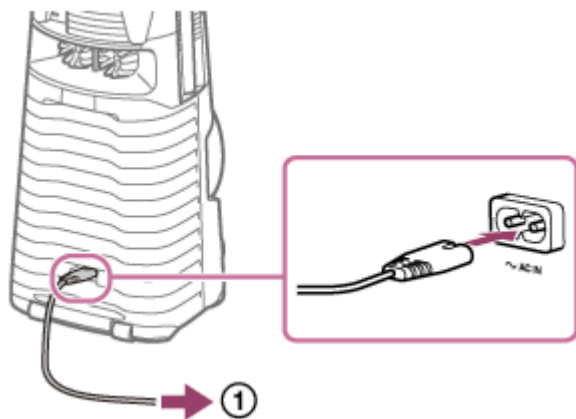

The system is turned on in the demonstration mode and lighting starts flashing automatically.

Related Topic

- [Turning the power on](#)
- [Turning off the demonstration mode](#)

Home Audio System
MHC-V73D

Inserting batteries to the remote control

- 1 Insert the two supplied R03 or LR03 (size AAA) batteries, matching the polarities.

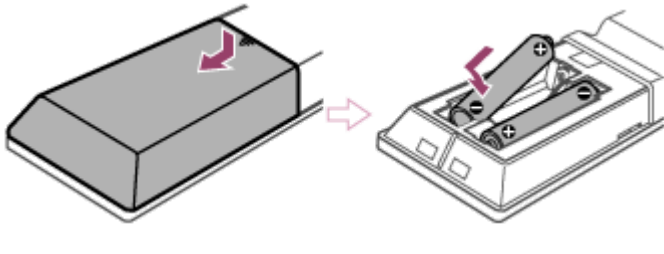

To operate the system using the remote control

Point the remote control at the system's remote control sensor.

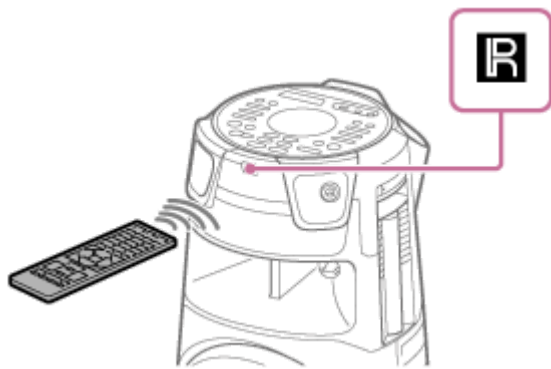

Hint

- Do not mix an old battery with a new one or mix different types of batteries.
- If you do not use the remote control for a long period of time, remove the batteries to avoid damage from battery leakage and corrosion.

Home Audio System
MHC-V73D

Turning the power on

- 1 Press  (power).

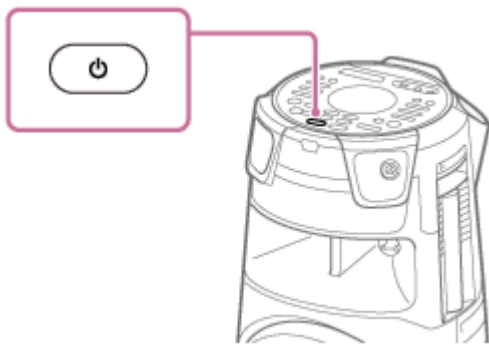

Related Topic

- [Turning the power off \(Standby mode\)](#)
- [Connecting the system to an AC outlet](#)

Turning the power off (Standby mode)

- 1 Press  (power).

[STANDBY] flashes on the display.

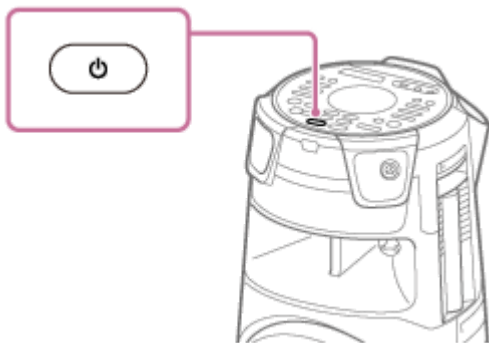

Related Topic

- [Auto Standby function](#)
- [Using the BLUETOOTH standby function](#)

Home Audio System
MHC-V73D

Auto Standby function

The system enters standby mode automatically in about 15 minutes when there is no operation or audio signal output. At the time of purchase, the Auto Standby function is set to on.

Note

- The Auto Standby function does not work in the following cases:
 - during TUNER FM function.
 - when the Sleep Timer is activated.
 - when an external device is connected to the MIC1 jack or the MIC2/GUITAR jack.
 - when the system is a Party Guest for the Wireless Party Chain function or the Guest system for the Stereo Pair function.

To turn off/on the Auto Standby function

1. Press **OPTIONS**.
The options menu appears on the display.
2. Press **▲** (up)/ **▼** (down) repeatedly to select [AutoSTBY], then press **⏏** (enter).
3. Press **▲** (up)/ **▼** (down) repeatedly to select [ON] or [OFF], then press **⏏** (enter).

To exit the options menu

Press **OPTIONS**.

Hint

- [AutoSTBY] flashes on the display about 2 minutes before the system enters standby mode.

Hooking up TV

Before connecting cables, be sure to disconnect the AC power cord (mains lead).

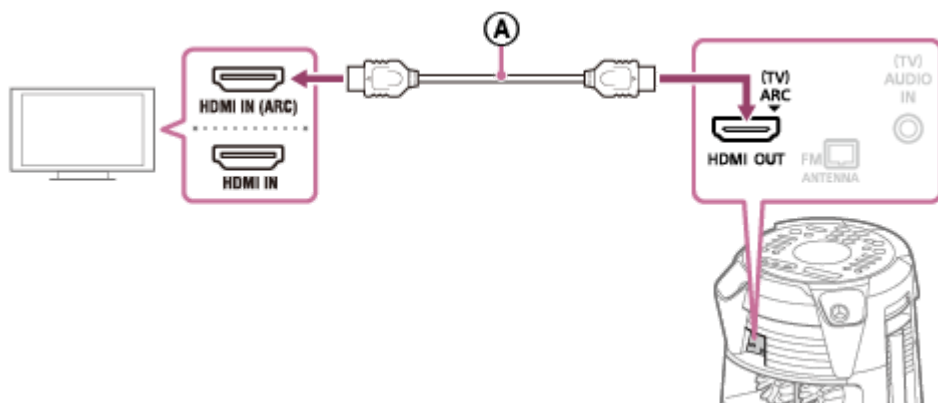

Ⓐ : High Speed HDMI Cable with Ethernet (not supplied)

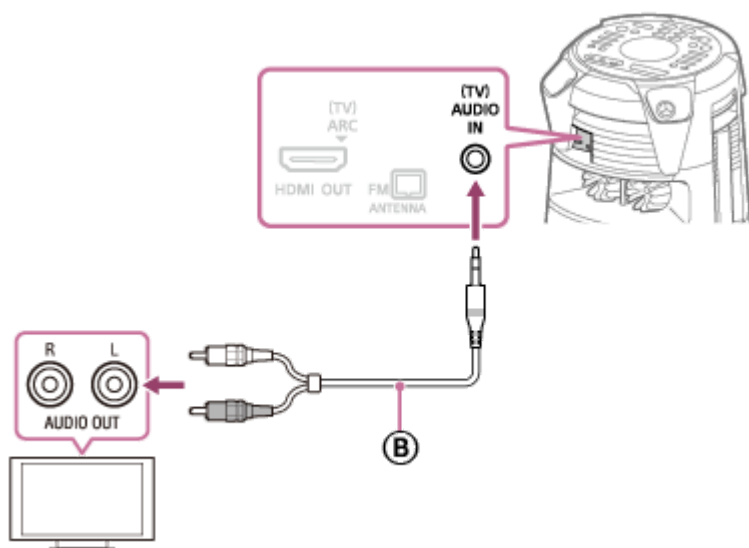

Ⓑ : Audio cable (not supplied)

Select the connection methods according to the connectors on your TV.

Available input connector on your TV	HDMI connector with "ARC"*1	HDMI connector without "ARC"	Without HDMI connector
To watch video	Ⓐ	Ⓐ	Not available
To listen to TV sound*2	Ⓐ	Ⓑ	Ⓑ

*1 The Audio Return Channel (ARC) function enables the TV to output sound through the system with just an HDMI cable connection. To set the ARC function on this system, see [Settings menu](#). To check the compatibility of your TV's ARC function, refer to the operating instructions supplied with your TV.

*2 To listen to TV sound, press FUNCTION repeatedly to select [TV].

To change the color system (Except for Latin American, Brazilian, European, and Russian models)

Set the color system depending on the color system of your TV.

Each time you perform the procedure below, the color system changes as follows:

NTSC ↔ PAL

Use the controls on the system to perform this operation.

1. Press  (power) to turn on the system.
2. Touch FUNCTION repeatedly to select [DVD/CD].
3. Hold down MIC ECHO and MEGA BASS for more than 3 seconds.
[NTSC] or [PAL] appears on the display.

Hint

- You can also enjoy the sound of audio/video equipment via the system. (See [Listening to music of an external audio device, etc..](#))
- If the audio output level from the system is low when connecting the optional equipment, try adjusting the audio output settings on the connected equipment. It may improve the audio output level. For details, refer to the operating instructions of your equipment.

Note

- Do not connect this system to the TV through the video deck.
- When the audio signals input to the HDMI OUT (TV) ARC connector of the system are other than 2-channel Linear PCM signals, the messages [CODE 01] and [SGNL ERR] appear on the display of the system. (See [About messages.](#))

Home Audio System
MHC-V73D

Performing Quick Setup

Before using the system, you can make the minimum basic adjustments in the quick setup.

- 1 **Connect the system to your TV.** (See [Hooking up TV.](#))
- 2 **Turn on your TV and select the input according to the connection.**
- 3 **Press  (power) to turn on the system.**
- 4 **Press FUNCTION repeatedly to select [DVD/CD].**

The guide message [Press ENTER to run QUICK SETUP.] appears at the bottom of the TV screen.





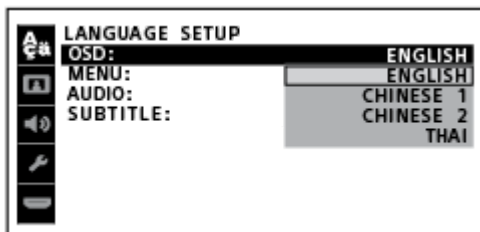

Note

- The guide message appears when you turn on the system for the first time or after performing [RESET]. (See [Returning the setup menu settings to the default.](#))

- 5 **Press  (enter) without loading a disc.**

[LANGUAGE SETUP] appears on the TV screen. Displayed items may vary depending on country or region.



- 6 **Press  (up)/  (down) repeatedly to select a language, then press  (enter).**
- 7 **Press  (up)/  (down) repeatedly to select the setting that matches your TV type, then press  (enter).**

After [QUICK SETUP is complete.] appears on the TV screen, the system is ready for playback.

To quit the quick setup

Hold down SHIFT and press SETUP.

To change the setting manually

See [Settings menu.](#)

Home Audio System
MHC-V73D

Using the mic holder(s)

You can put microphones (not supplied) in the mic holders. To use the mic holder, unfold it with your finger as illustrated below.

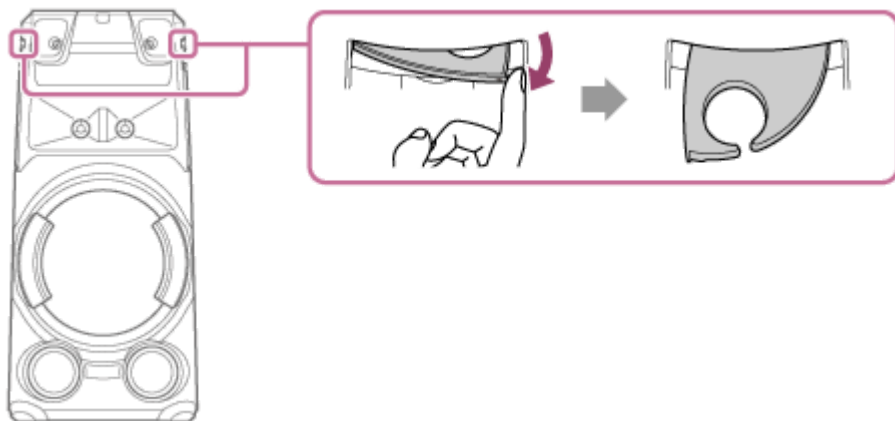

Note

- The mic holders are designed for placing microphones only.
- Do not hold the mic holders when carrying the system.
- Before placing microphones in the mic holders, touch MIC/GUITAR LEVEL - on the system repeatedly to reduce the microphone volume level to a minimum level.

Related Topic

- [Singing karaoke](#)

Home Audio System
MHC-V73D

Turning off the demonstration mode

The demonstration mode is set to on at the time of purchase. When you connect the system to an AC outlet using the AC power cord (mains lead), the demonstration starts automatically. The messages about the main features of this system scroll across the display and the lighting turns on.

- 1 While the system is turned off, press **DISPLAY** repeatedly until the demonstration is turned off (**Power Saving Mode**).

The display and the lighting are turned off to conserve power.

To activate the demonstration mode

Press **DISPLAY**.

Hint

- To turn off the lighting during demonstration, press **PARTY LIGHT**.

Hooking up TV

Before connecting cables, be sure to disconnect the AC power cord (mains lead).

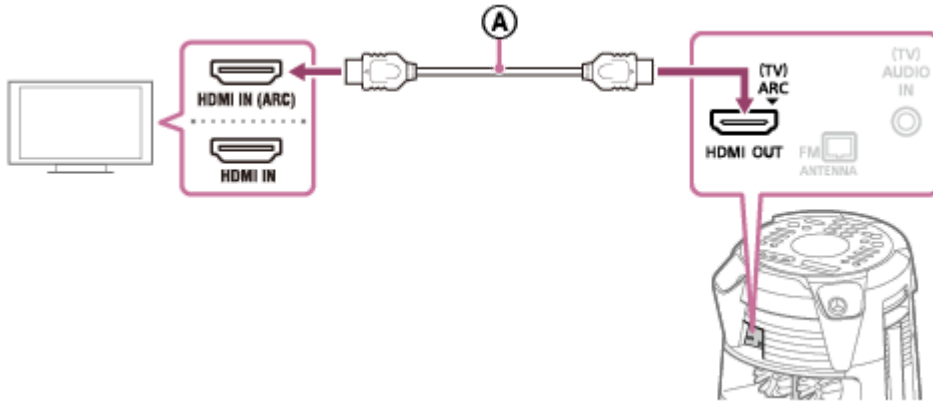

Ⓐ : High Speed HDMI Cable with Ethernet (not supplied)

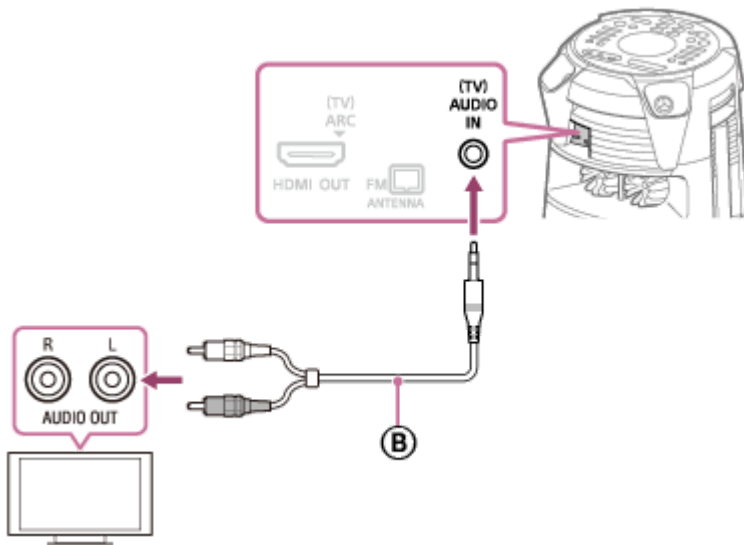

Ⓑ : Audio cable (not supplied)

Select the connection methods according to the connectors on your TV.

Available input connector on your TV	HDMI connector with "ARC"*1	HDMI connector without "ARC"	Without HDMI connector
To watch video	Ⓐ	Ⓐ	Not available
To listen to TV sound*2	Ⓐ	Ⓑ	Ⓑ

*1 The Audio Return Channel (ARC) function enables the TV to output sound through the system with just an HDMI cable connection. To set the ARC function on this system, see [Settings menu](#). To check the compatibility of your TV's ARC function, refer to the operating instructions supplied with your TV.

*2 To listen to TV sound, press FUNCTION repeatedly to select [TV].

To change the color system (Except for Latin American, Brazilian, European, and Russian models)

Set the color system depending on the color system of your TV.

Each time you perform the procedure below, the color system changes as follows:

NTSC ↔ PAL

Use the controls on the system to perform this operation.

1. Press  (power) to turn on the system.
2. Touch FUNCTION repeatedly to select [DVD/CD].
3. Hold down MIC ECHO and MEGA BASS for more than 3 seconds.
[NTSC] or [PAL] appears on the display.

Hint

- You can also enjoy the sound of audio/video equipment via the system. (See [Listening to music of an external audio device, etc..](#))
- If the audio output level from the system is low when connecting the optional equipment, try adjusting the audio output settings on the connected equipment. It may improve the audio output level. For details, refer to the operating instructions of your equipment.

Note

- Do not connect this system to the TV through the video deck.
- When the audio signals input to the HDMI OUT (TV) ARC connector of the system are other than 2-channel Linear PCM signals, the messages [CODE 01] and [SGNL ERR] appear on the display of the system. (See [About messages.](#))

Home Audio System
MHC-V73D

Using the Control for HDMI function

Connecting a TV compatible with the Control for HDMI function* by HDMI cable (High Speed HDMI Cable with Ethernet, not supplied) enables you to easily operate the device by a TV remote control.

The following functions can be used with the Control for HDMI function.

- System Power Off function
- System Audio Control function
- Audio Return Channel (ARC) function
- One-Touch Play function
- Remote Easy Control function
- Language Follow function

* Control for HDMI is a standard used by CEC (Consumer Electronics Control) for allowing HDMI (High-Definition Multimedia Interface) devices to control each other.

Note

- These functions may work with devices other than those manufactured by Sony, but operation is not guaranteed.

Preparing to use the Control for HDMI function

1 Hold down SHIFT and press SETUP.

The setup menu appears on the TV screen.

2 Set [HDMI SETUP] – [CONTROL FOR HDMI] to [ON].

At the time of purchase, this setting is set to [ON]. For details, see [Settings menu](#).

Enable the Control for HDMI function settings for the TV connected to the system.

If you enable the Control for HDMI ("BRAVIA" Sync) function when using a TV manufactured by Sony, the Control for HDMI function of the system is also enabled automatically. When settings are completed, [COMPLETE] appears on the display.

System Power Off function

When you turn off the TV, the system will turn off automatically.

1. Hold down SHIFT and press SETUP.

The setup menu appears on the TV screen.

2. Set [HDMI SETUP] – [STANDBY LINKED TO TV] to [ON] or [AUTO].

At the time of purchase, this setting is set to [AUTO]. For details, see [Settings menu](#).

Note

- The connected device may not turn off depending on the status of the device.

System Audio Control function

If you turn on the system while you are watching the TV, the TV sound will be output from the speakers of the system. The volume of the system can be adjusted using the TV's remote control.

If the TV sound was output from the speakers of the system the previous time you watched the TV, the system will be turned on automatically when you turn on the TV again.

Operations can also be made by the TV's menu. For details, refer to the operating instructions of your TV.

Note

- The system's volume level is displayed on the TV screen depending on the TV. It may differ from the volume level on the display.
- Depending on the settings of the TV, the System Audio Control function may not be available. For details, refer to the operating instructions of your TV.

Audio Return Channel (ARC) function

If the system is connected to a TV's HDMI IN connector compatible with the Audio Return Channel (ARC) function, you can listen to TV sound from the speakers of the system without connecting an audio cable (not supplied).

1. Hold down SHIFT and press SETUP.
The setup menu appears on the TV screen.
2. Set [HDMI SETUP] – [AUDIO RETURN CHANNEL] to [ON].
At the time of purchase, this setting is set to [ON]. For details, see [Settings menu](#).

Note

- If the TV is not compatible with the Audio Return Channel (ARC) function, an audio cable (not supplied) needs to be connected.

One-Touch Play function

When you press ► (play) in DVD/CD or USB function, the TV is turned on automatically. The TV's input is switched to the HDMI input which the system is connected.

Note

- Depending on the TV, the beginning part of content being played may not play correctly.

Remote Easy Control function

You can select the system by using SYNC MENU and operate the system.

This function can be used if the TV supports the link menu. For details, refer to the operating instructions of your TV.

Note

- In the TV's link menu, the system is recognized by the TV as "Player."
- Some operations may not be available with some TVs.

Language Follow function

When you change the language for the on-screen display of the TV, the system's on-screen display language is also changed.

Related Topic

Home Audio System
MHC-V73D

Listening to music of an external audio device, etc.

You can listen to music of an external audio device by connecting the device to the system with an audio cable (not supplied).

1 Press  (volume) - (or touch VOLUME - on the system) repeatedly until [VOL MIN] appears on the display.

2 Connect an external audio device and the (TV) AUDIO IN jack on the system with an audio cable.

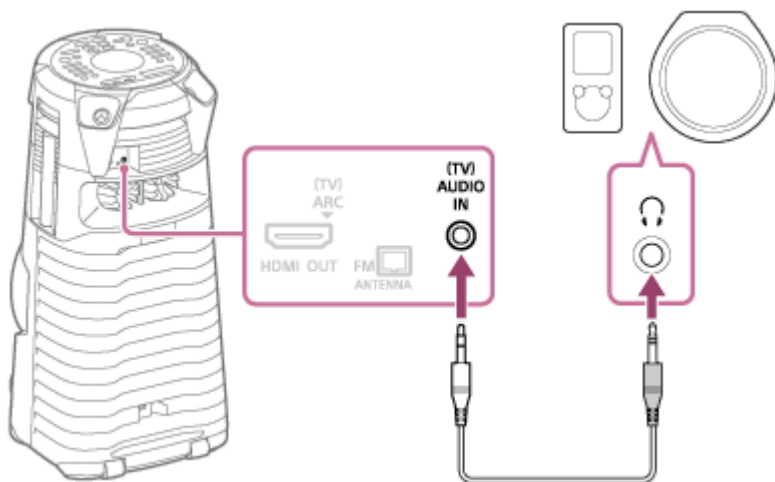

3 Press FUNCTION repeatedly to select [AUDIO IN].

4 Turn on the connected device, and start playback.

5 Adjust the volume.

Adjust the volume on the system first. If the volume level is still too low, adjust the volume level of the connected device.

Hint

- The system may enter standby mode automatically if the volume level of the connected external audio device is too low. Adjust the volume level of the device. To turn off the Auto Standby function, see "[Auto Standby function](#)."

Related Topic

- [Auto Standby function](#)

Listening to music of an external audio device, etc.

You can listen to music of an external audio device by connecting the device to the system with an audio cable (not supplied).

1 Press  (volume) - (or touch VOLUME - on the system) repeatedly until [VOL MIN] appears on the display.

2 Connect an external audio device and the (TV) AUDIO IN jack on the system with an audio cable.

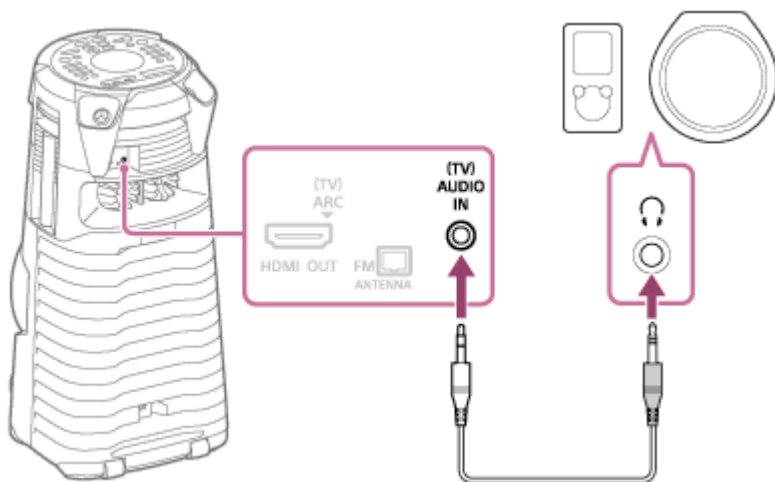

3 Press FUNCTION repeatedly to select [AUDIO IN].

4 Turn on the connected device, and start playback.

5 Adjust the volume.

Adjust the volume on the system first. If the volume level is still too low, adjust the volume level of the connected device.

Hint

- The system may enter standby mode automatically if the volume level of the connected external audio device is too low. Adjust the volume level of the device. To turn off the Auto Standby function, see "[Auto Standby function](#)."

Related Topic

- [Auto Standby function](#)

Playing a disc

You can play a disc on the system by following these steps.

- 1 Press **FUNCTION** repeatedly to select [DVD/CD].
- 2 Touch **▲** (open/close) on the system to open the disc tray and load a disc with the label facing up on the disc tray.



- 3 Touch **▲** (open/close) on the system again to close the disc tray.
Do not forcibly push the disc tray to close it as this may cause a malfunction.
- 4 If the disc is in DATA CD/DATA DVD format, press **MEDIA MODE** repeatedly to select [MUSIC] or [VIDEO].
- 5 Press **▶** (play) to start playback.

Other operations

Depending on the disc or file, the function may not work.

To	Do this
Stop playback	Press ■ (stop).
Pause playback	Press ⏸ (pause).
Resume playback or return to normal playback	Press ▶ (play).
Cancel the resume point	Press ■ (stop) twice.

To	Do this
Select a track, file, chapter, or scene	Press ◀◀ (previous) or ▶▶ (next) during playback. Or, hold down SHIFT and press the numeric buttons, then press ⏏ (enter).
Select a folder	Press 📁 (folder) -/+ repeatedly.
Display the DVD title	Press DVD TOP MENU.
View DVD menu	Press DVD/TUNER MENU.
Locate a point quickly in fast forward or fast reverse (Lock Search)	Press ◀◀ (fast reverse) or ▶▶ (fast forward) during playback. Each time you press ◀◀ (fast reverse) or ▶▶ (fast forward), the playback speed changes.
Watch frame by frame (Slow-motion Play)	Press ⏸ (pause), then press ◀◀ (slow back) or ▶▶ (slow forward). Each time you press ◀◀ (slow back) or ▶▶ (slow forward), the playback speed changes.

To play from a specific file

1. Press MEDIA MODE repeatedly to select [MUSIC] or [VIDEO] on the TV screen.
2. Press SEARCH to display the folder list on the TV screen.
3. Press ⬆ (up)/ ⬇ (down) repeatedly to select the folder you want.
4. Press ⏏ (enter) to display the file list on the TV screen.
To return to folder list, press RETURN.
5. Press ⬆ (up)/ ⬇ (down) repeatedly to select the file you want, then press ⏏ (enter).

Related Topic

- [Hooking up TV](#)

Home Audio System
MHC-V73D

Various disc playback operations

Depending on the disc or file, the function may not work.

Searching a specific track (for AUDIO CD)

Hold down SHIFT and press the numeric buttons to select the track you want, then press **[+]** (enter).

Searching a specific title/chapter/scene/track/index (for DVD VIDEO/VIDEO CD)

1. Press SEARCH repeatedly during playback to select the search mode.
2. Hold down SHIFT and press the numeric buttons to enter the title, chapter, scene, track, or index number you want, then press **[+]** (enter).
Playback starts.

Note

- For VIDEO CD with PBC playback, press SEARCH to search the scene.
- For VIDEO CD without PBC playback, press SEARCH to search the track and index.

To search for a particular point using the time code (for DVD VIDEO)

1. Press SEARCH repeatedly during playback to select the time search mode.
2. Hold down SHIFT and press the numeric buttons to enter the time code, then press **[+]** (enter).
Example: To find a scene at 2 hours, 10 minutes, and 20 seconds, hold down SHIFT and press 2, 1, 0, 2, 0 ([2:10:20]).
If you make a mistake, hold down SHIFT and press CLEAR to cancel the number.

To search using the DVD menu (for DVD VIDEO)

1. Press DVD/TUNER MENU.
2. Press **▲** (up)/ **▼** (down)/ **◀** (left)/ **▶** (right), or hold down SHIFT and press the numeric buttons, to select the title or item you want, then press **[+]** (enter).

Changing the camera angles (for DVD VIDEO)

Press ANGLE repeatedly during playback to select the camera angle you want.

Selecting the subtitle setting (for DVD VIDEO)

Press SUBTITLE repeatedly during playback to select the subtitle language you want or turn off the subtitle.

Changing the language/sound (for DVD VIDEO/VIDEO CD/AUDIO CD/DATA CD/DATA DVD)

Press AUDIO repeatedly during playback to select the audio format or mode you want.

DVD VIDEO

You can select audio format or language when the source contains multiple audio formats or multilingual audio.

When 4 digits are displayed, they indicate a language code. See [Language code list](#) to confirm which language the code represents. When the same language is displayed two or more times, the DVD VIDEO is recorded in multiple audio formats.

VIDEO CD/AUDIO CD/audio file

You can change the sound output.

- [STEREO]^{*}: The stereo sound.
- [1/L]/[2/R]: The monaural sound of the left or right channel.

SUPER VIDEO CD

- [1:STEREO]^{*}: The stereo sound of audio track 1.
- [1:1/L]/[1:2/R]: The monaural sound of the left or right channel of audio track 1.
- [2:STEREO]: The stereo sound of audio track 2.
- [2:1/L]/[2:2/R]: The monaural sound of the left or right channel of audio track 2.

* Default setting

Playing a VIDEO CD with PBC functions (for VIDEO CD)

You can use the PBC (Playback Control) menu to enjoy the interactive features of VIDEO CD (VIDEO CD Version 2.0 and Super VCD).

1. Press ► (play) to play a VIDEO CD with PBC functions.
The PBC menu appears on the TV screen.
2. Hold down SHIFT and press the numeric buttons to select the item number you want, then press + (enter).
3. Continue playback according to the instructions on the menu.

Note

- PBC playback is canceled when Repeat Play is activated.

To cancel PBC playback

1. Press ◀◀ (previous) or ▶▶ (next), or hold down SHIFT and press the numeric buttons, to select a track when playback is stopped.
2. Press ► (play) or + (enter).
Playback starts from the selected track.

To return to PBC playback

Press ■ (stop) twice, then press ► (play).

Multi-disc resume play (for DVD VIDEO/VIDEO CD)

This system can store playback resume points for up to 6 discs and resumes playback when you insert the same disc again. If you store a playback resume point for the 7th disc, the resume point for the first disc will be deleted. To activate this function, set [MULTI-DISC RESUME] in [SYSTEM SETUP] to [ON].

Note

- To play back from the beginning of the disc, press ■ (stop) twice, then press ► (play).

Related Topic

- [Hooking up TV](#)

5-014-121-11(2) Copyright 2020 Sony Corporation

Home Audio System
MHC-V73D

Using play mode

Depending on the disc or file, the function may not work.

Playing in sequential order or random order (Normal Play/Shuffle Play) (for AUDIO CD/DATA CD/DATA DVD)

When playback is stopped, press PLAY MODE repeatedly.

- [DISC]^{*1}: Plays the disc.
- [FOLDER]^{*2}: Plays all playable files in the specified folder on the disc.
- [DISC (SHUFFLE)]: Shuffles all audio files on the disc.
- [FOLDER (SHUFFLE)]^{*2}: Shuffles all audio files in the specified folder on the disc.

*1 Default setting

*2 Cannot be selected for AUDIO CD.

Note

- [FLDR] and [SHUF] light off on the display when Normal Play is set to [DISC].
- [FLDR] lights up on the display when Normal Play is set to [FOLDER].
- [SHUF] lights up on the display when Shuffle Play is set to [DISC (SHUFFLE)].
- [FLDR] and [SHUF] light up on the display when Shuffle Play is set to [FOLDER (SHUFFLE)].
- Shuffle Play cannot be performed for video files.
- Shuffle Play is canceled when you:
 - open the disc tray.
 - perform Synchronized Transfer.
 - change the MEDIA MODE setting.
- Shuffle Play may be canceled when you select a folder or a track to play back.

Playing repeatedly (Repeat Play) (for DVD VIDEO/VIDEO CD/AUDIO CD/DATA CD/DATA DVD)

Press REPEAT/FM MODE repeatedly.

Depending on the type of disc or file, some settings may not be available.

- [OFF]^{*}: Does not play back repeatedly.
- [ALL]: Repeats all tracks or files in the selected play mode.
- [DISC]: Repeats all contents (DVD VIDEO and VIDEO CD only).
- [TITLE]: Repeats the current title (DVD VIDEO only).

- [CHAPTER]: Repeats the current chapter (DVD VIDEO only).
- [TRACK]: Repeats the current track.
- [FILE]: Repeats the current video file.

* Default setting

To cancel Repeat Play

Press REPEAT/FM MODE repeatedly to select [OFF].

Note

- [REPEAT] lights up on the display when Repeat Play is set to [ALL] or [DISC].
- [REPEAT1] lights up on the display when Repeat Play is set to [TITLE], [CHAPTER], [TRACK] or [FILE].
- You cannot perform Repeat Play with VIDEO CD during PBC playback.
- Depending on the DVD VIDEO, you cannot perform Repeat Play.
- Repeat Play is canceled when you:
 - open the disc tray.
 - turn off the system (DVD VIDEO and VIDEO CD only).
 - change the function (DVD VIDEO and VIDEO CD only).
 - perform Synchronized Transfer.
 - change the MEDIA MODE setting.

Home Audio System
MHC-V73D

Viewing information of a disc

You can view the following information of a disc on TV screen and the display.

Hold down SHIFT and press  DISPLAY repeatedly during playback.

Example:

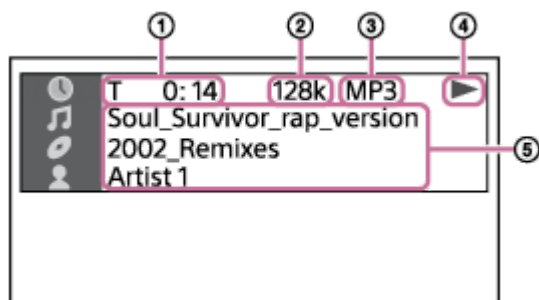

1. Playback information
Playing time and remaining time
2. Bit rate
3. Media type
4. Playback status
5. Various names
 - File name, folder name
 - Song name, artist name, album name

Note

- Depending on the source being played, some information or characters cannot be displayed.
- Depending on the play mode, the information displayed may be different.
- The system can support ID3 ver. 1.0/1.1/2.2/2.3.
- If the name contains characters which cannot be displayed, those characters will be displayed as [].

Press DISPLAY repeatedly when the system is turned on.

You can view the information as follows:

- Playing time/remaining time
- File name, folder name
- Song name, artist name, album name

Note

- The name may not be displayed depending on the characters.
- Playing time of audio files and video files may not be displayed correctly.
- The elapsed playing time for an audio file encoded using a VBR (variable bit rate) is not displayed correctly.

Related Topic

- [Hooking up TV](#)

5-014-121-11(2) Copyright 2020 Sony Corporation

Restricting playback of the disc (Parental Control)

You can restrict playback of DVD VIDEOS according to a predetermined level. Scenes may be skipped or replaced with different scenes.

- 1 When playback is stopped, hold down SHIFT and press SETUP.
- 2 Press **↑** (up)/ **↓** (down) repeatedly to select [SYSTEM SETUP], then press **⏏** (enter).
- 3 Press **↑** (up)/ **↓** (down) repeatedly to select [PARENTAL CONTROL], then press **⏏** (enter).
- 4 Hold down SHIFT and press the numeric buttons to enter or re-enter your 4-digit password, then press **⏏** (enter).
- 5 Press **↑** (up)/ **↓** (down) repeatedly to select [STANDARD], then press **⏏** (enter).
- 6 Press **↑** (up)/ **↓** (down) repeatedly to select a geographic area as the playback limitation level, then press **⏏** (enter).

The area is selected.
When you select [OTHERS →], enter the area code for the geographic area you want according to [Parental Control area code list](#) by holding down SHIFT and press the numeric buttons.
- 7 Press **↑** (up)/ **↓** (down) repeatedly to select [LEVEL], then press **⏏** (enter).
- 8 Press **↑** (up)/ **↓** (down) repeatedly to select the level you want, then press **⏏** (enter).

The lower the value, the stricter the limitation.

To turn off the parental control function

Set [LEVEL] to [OFF] in step 8 .

To play back a disc for which the parental control is set

1. Load the disc and press **▶** (play).

The display for entering your password appears on the TV screen.
2. Hold down SHIFT and press the numeric buttons to enter or re-enter your 4-digit password, then press **⏏** (enter).

The system starts playback.

If you forget your password

1. Remove the disc and repeat steps 1 to 3 .
2. Hold down SHIFT and press the numeric buttons to enter a password [199703], then press **⏏** (enter).

3. Follow the on-screen instructions and enter a new 4-digit password.

4. Reload the disc and press ► (play).

You need to enter your new password again.

Related Topic

- [Hooking up TV](#)

5-014-121-11(2) Copyright 2020 Sony Corporation

Home Audio System
MHC-V73D

Connecting with a USB device

Compatible USB devices

- USB devices compliant with USB Mass Storage Class

Some USB devices may not work with the system even if the devices meet the above conditions.
Using iPhone/iPod devices via a USB connection is not supported.

- 1 Press **FUNCTION** repeatedly to select **[USB]**.
- 2 Connect a USB device to the ψ (USB) port on the system.

Note

- You can use a USB adaptor (not supplied) to connect the USB device to the system if the USB device cannot be plugged into the ψ (USB) port on the system.

Related Topic

- [Playing a USB device](#)

Playing a USB device

- 1 Press **FUNCTION** repeatedly to select **[USB]**.
- 2 Connect a USB device to the **ψ (USB)** port on the system.
- 3 Press **MEDIA MODE** to select **[MUSIC]** or **[VIDEO]**.
- 4 Press **▶ (play)** to start playback.

Other operations

Depending on the file, the function may not work.

To	Do this
Stop playback	Press ■ (stop) .
Pause playback	Press ⏸ (pause) .
Resume playback or return to normal playback	Press ▶ (play) .
Cancel the resume point	Press ■ (stop) twice.
Select a file	Press ⏮ (previous) or ⏭ (next) during playback. Or, hold down SHIFT and press the numeric buttons, then press ⏏ (enter) .
Select a folder	Press 📁 (folder) +/- repeatedly.
Locate a point quickly in fast forward or fast reverse (Lock Search)	Press ⏮ (fast reverse) or ⏭ (fast forward) during playback. Press ▶ (play) to resume playback. Each time you press ⏮ (fast reverse) or ⏭ (fast forward) , the playback speed changes.
Change the sound output	Press AUDIO repeatedly during playback. <ul style="list-style-type: none"> ● [STEREO]: The stereo sound ● [1/L]/[2/R]: The monaural sound of the left or right channel

To play from a specific file

1. Press **MEDIA MODE** repeatedly to select **[MUSIC]** or **[VIDEO]** on the TV screen.
2. Press **SEARCH** to display the folder list on the TV screen.
3. Press **▲ (up)**/**▼ (down)** repeatedly to select the folder you want.
4. Press **⏏ (enter)** to display the file list on the TV screen.

To return to folder list, press RETURN.

5. Press **↑** (up)/ **↓** (down) repeatedly to select the file you want, then press **⏎** (enter).

Note

- You can use a USB adaptor (not supplied) to connect the USB device to the system if the USB device cannot be plugged into the ψ (USB) port on the system.

Related Topic

- [Viewing information of a USB device](#)

5-014-121-11(2) Copyright 2020 Sony Corporation

Home Audio System
MHC-V73D

Using play mode

Depending on the file, the function may not work.

Playing in sequential order or random order (Normal Play/Shuffle Play) (for USB)

When playback is stopped, press PLAY MODE repeatedly.

- [ONE USB DEVICE]*: Plays the USB device.
- [FOLDER]: Plays all playable files in the specified folder on the USB device.
- [ONE USB DEVICE (SHUFFLE)]: Shuffles all audio files on the USB device.
- [FOLDER (SHUFFLE)]: Shuffles all audio files in the specified folder on the USB device.

* Default setting

Note

- [FLDR] and [SHUF] light off on the display when Normal Play is set to [ONE USB DEVICE].
- [FLDR] lights up on the display when Normal Play is set to [FOLDER].
- [SHUF] lights up on the display when Shuffle Play is set to [ONE USB DEVICE (SHUFFLE)].
- [FLDR] and [SHUF] light up on the display when Shuffle Play is set to [FOLDER (SHUFFLE)].
- Shuffle Play cannot be performed for video files.
- Shuffle Play is canceled when you:
 - perform Synchronized Transfer.
 - change the MEDIA MODE setting.
- Shuffle Play may be canceled when you select a folder to play back.

Playing repeatedly (Repeat Play) (for USB)

Press REPEAT/FM MODE repeatedly.

Depending on the type of file, some settings may not be available.



- [OFF]*: Does not play back repeatedly.
- [ALL]: Repeats all files in the selected play mode.
- [TRACK]: Repeats the current audio file.
- [FILE]: Repeats the current video file.

* Default setting

To cancel Repeat Play

Press REPEAT/FM MODE repeatedly to select [OFF].

Note

- [] lights up on the display when Repeat Play is set to [ALL].
- [] lights up on the display when Repeat Play is set to [TRACK] or [FILE].
- Repeat Play is canceled when you:
 - perform Synchronized Transfer.
 - change the MEDIA MODE setting.

Home Audio System
MHC-V73D

Viewing information of a USB device

You can view the following information of a USB device on TV screen and the display.

Hold down SHIFT and press  DISPLAY repeatedly during playback.

Example:

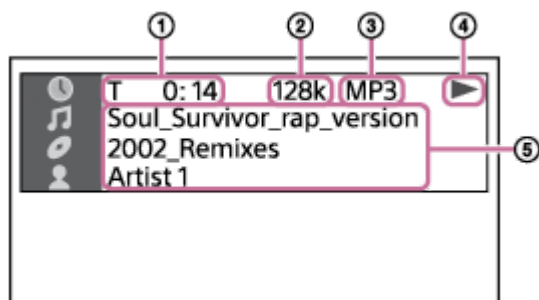

1. Playback information
Playing time and remaining time
2. Bit rate
3. Media type
4. Playback status
5. Various names
 - File name, folder name
 - Song name, artist name, album name

Note

- Depending on the source being played, some information or characters cannot be displayed.
- Depending on the play mode, the information displayed may be different.
- The system can support ID3 ver. 1.0/1.1/2.2/2.3.
- If the name contains characters which cannot be displayed, those characters will be displayed as [].

Press DISPLAY repeatedly when the system is turned on.

You can view the information as follows:

- Playing time/remaining time
- File name, folder name
- Song name, artist name, album name

Note

- The name may not be displayed depending on the characters.
- Playing time of audio files and video files may not be displayed correctly.
- The elapsed playing time for an audio file encoded using a VBR (variable bit rate) is not displayed correctly.

5-014-121-11(2) Copyright 2020 Sony Corporation

Home Audio System
MHC-V73D

Transferring music from a disc

You can transfer music from a disc (AUDIO CD or MP3 disc only) to a USB device connected to the ψ (USB) port on the system.

The audio format of files transferred by this system is MP3.

Note on copyright-protected content

The transferred music is limited to private use only. Use of the music beyond this limit requires permission of the copyright holders.

Note

- Do not remove the USB device during transfer operation. Doing so may corrupt the data on the USB device or damage the USB device itself.
- MP3 files are transferred with the same bit rate as the original files.
- When transferring from AUDIO CD, you may select the bit rate before transferring.
- USB transfer operation is prohibited when the disc tray is opened.

1 Connect a transferable USB device to the ψ (USB) port on the system.

Note

- You can use a USB adaptor (not supplied) to connect the USB device to the system if the USB device cannot be plugged into the ψ (USB) port on the system.

2 Press **OPTIONS**.

The options menu appears on the display.

3 Press **↑** (up)/ **↓** (down) repeatedly to select **[BIT RATE]**, then press **⏏** (enter).

4 Press **↑** (up)/ **↓** (down) repeatedly to select the bit rate you want, then press **⏏** (enter).

- [128 KBPS]: Encoded MP3 files have smaller file size and lower audio quality.
- [256 KBPS]: Encoded MP3 files have bigger file size but higher audio quality.

Press **OPTIONS** to exit the menu.

5 Press **FUNCTION** repeatedly to select **[DVD/CD]**, then load a disc.

6 Prepare the sound source.

- Synchronized Transfer: Transfer all tracks or MP3 files from a disc to USB device.
If the system starts playback automatically, press **■** (stop) twice to stop the playback fully.
When playback is stopped, press **PLAY MODE** repeatedly to select the play mode you want.

Note

- If you start transferring in Shuffle Play or Repeat Play, the selected play mode changes to Normal Play automatically.

- REC1 Transfer: Transfer a single track or MP3 file during playback. Select the track or MP3 file you want to transfer, then start playback.

7 Press REC TO USB.

[PUSH ENTER] appears on the display.

8 Press (enter).

The transfer starts, then [DO NOT REMOVE] appears on the display. Do not remove the USB device until the transfer is complete.

When the transfer is complete, the system performs as follows:

- Synchronized Transfer:
The disc stops automatically.
- REC1 Transfer:
The disc continues to play the next track or file.

To stop transfer

Press  (stop).

Note

- You cannot transfer MP3 files on a UDF (Universal Disk Format) formatted disc to the USB device.
- While transferring, no sound is output.
- CD-TEXT information is not transferred to the created MP3 files.
- The transfer stops automatically if:
 - the USB device runs out of space during transfer.
 - the number of audio files or folders on the USB device reaches the limit that the system can recognize.
- If a folder or file that you are trying to transfer already exists on the USB device with the same name, a sequential number is added after the name without overwriting the original folder or file.
- You cannot perform the following operations during transfer:
 - Open the disc tray.
 - Select another track or file.
 - Pause playback or find a point in the track or file.
 - Change the function.
- When transferring music to a WALKMAN[®] using “Media Manager for WALKMAN,” be sure to transfer in MP3 format.
- When connecting a WALKMAN[®] to the system, be sure to connect after the display [Creating Library] or [Creating Database] on the WALKMAN[®] has disappeared.

Folder and file generation rules

Maximum number of MP3 files that can be generated.

- 298 folders
- 650 files in a folder
- 650 files in REC1-CD or REC1-MP3 folder

These numbers may vary depending on the file or folder configuration.

When transferring to a USB device, a [MUSIC] folder is created directly below [ROOT]. Folders and files are generated within this [MUSIC] folder according to the transfer method and source as follows:

Synchronized Transfer

- When transferring all tracks from an AUDIO CD
Folder name: [CDDA0001]*
File name: [TRACK001]*
- When transferring MP3 files from a disc
Folder name: Same as the source
File name: Same as the source

REC1 Transfer

- When transferring a track from an AUDIO CD
Folder name: [REC1-CD]
File name: [TRACK001]*
- When transferring an MP3 file from a disc
Folder name: [REC1-MP3]
File name: Same as the source

* Folder and file numbers are assigned serially thereafter.

Erasing audio files or folders on the USB device

You can erase audio files or folders on the USB device connected to the system.

- 1 Press FUNCTION repeatedly to select [USB].**
- 2 Press MEDIA MODE repeatedly to select [MUSIC].**
- 3 When playback is stopped, press OPTIONS.**
The options menu appears on the display.
- 4 Press \blacktriangle (up)/ \blacktriangledown (down) repeatedly to select [ERASE], then press \square (enter).**
The folder list is displayed on the TV screen.
- 5 Press \blacktriangle (up)/ \blacktriangledown (down) repeatedly to select a folder, then press \square (enter).**
The file list is displayed on the TV screen.
- 6 Press \blacktriangle (up)/ \blacktriangledown (down) repeatedly to select an audio file you want to erase, then press \square (enter).**
If you want to erase all the audio files in the folder, select [ALL TRACKS] on the list. [FOLDER ERASE] or [TRACK ERASE] and [PUSH ENTER] appear on the display. To cancel erase operations, press \blacksquare (stop).
- 7 Press \square (enter).**
[COMPLETE] appears on the display. To exit the options menu, press OPTIONS.

Note

- You can erase the supported audio file, MP4 format file, and 3GP format file only.
- You cannot erase audio files or folders when Shuffle Play has been selected. Set the play mode to Normal Play before erasing.
- Erase operation is prohibited when the disc tray is opened.
- Do not remove the USB device during erase operations.

Related Topic

- [Hooking up TV](#)

Home Audio System
MHC-V73D

Pairing and connecting with BLUETOOTH devices

When pairing with two or more BLUETOOTH devices, perform the following pairing procedure for each device. Before operating the system, be sure to do the following:

- Place the BLUETOOTH device within 1 m (3.2 ft) from the system.
- Stop playback on the BLUETOOTH device.
- Turn down the volume of the BLUETOOTH device and system to avoid any sudden loud sound output from the system. Depending on the BLUETOOTH device, the volume of the device may be synchronized with the system.
- Prepare the operating instructions supplied with the BLUETOOTH device for reference.

1 Select the BLUETOOTH function.

1. Press  (power) to turn on the system.
2. Press FUNCTION repeatedly until [BLUETOOTH] appears on the display.

Hint

- When there is no pairing information on the system (for example, when you use the BLUETOOTH function for the first time after purchase), [PAIRING] flashes on the display and the system enters the pairing mode. Proceed to step **3**.
- When you turn on the system, the system tries to make a BLUETOOTH connection with the last connected BLUETOOTH device. If the device is nearby and its BLUETOOTH function is on, the BLUETOOTH connection is established automatically and the BLUETOOTH device name appears on the display. In this case, turn off the BLUETOOTH function or turn off the power of the currently connected BLUETOOTH device.

2 Hold down BLUETOOTH/ PAIRING on the system for more than 3 seconds until [PAIRING] flashes on the display.



3 Perform the pairing procedure on the BLUETOOTH device to detect the system.

When a list of detected devices appears on the display of the BLUETOOTH device, select [MHC-V73D]. Perform this step within 5 minutes, otherwise pairing will be canceled. In this case, repeat from step **2**. If a passkey* is required on the display of the BLUETOOTH device, enter [0000].

* The passkey may also be called a "passcode," "PIN code," "PIN number" or "password."

4 Make the BLUETOOTH connection from the BLUETOOTH device.

When the BLUETOOTH connection is established, the BLUETOOTH device name appears on the display and the BLUETOOTH indicator lights up.

To cancel the pairing operation

Hold down BLUETOOTH/  PAIRING on the system for more than 3 seconds until [BT AUDIO] appears on the display.

To erase pairing information

You can erase all pairing information by resetting the system.

Hint

- For details on operating a BLUETOOTH device, refer to the operating instructions supplied with the BLUETOOTH device.

Note

- For Apple iOS devices, the system is compatible with iOS 11.0 or later.
- Once the BLUETOOTH devices are paired, there is no need to pair them again, except in the following cases:
 - Pairing information has been deleted after re-pair, etc.
 - The system is already paired with 8 devices and another device is to be paired.
The system can be paired with up to 8 devices. If a new device is paired after 8 devices have already been paired, the device that was paired earliest is replaced by the new one.
 - The pairing information of the system has been deleted from the BLUETOOTH device.
 - After you reset the system, it may not be able to connect with your iPhone/iPod. In this case, delete the pairing information of the system on your iPhone/iPod, then perform the pairing operation again.
 - The system can be paired with multiple devices, but can only play music from one paired device at a time.

Related Topic

- [Terminating the BLUETOOTH connection \(After use\)](#)
- [The system does not operate properly.](#)

Home Audio System
MHC-V73D

Connecting with an NFC-compatible device by One-touch (NFC)

By touching the system with an NFC-compatible device such as a smartphone, the system turns on automatically, and then makes BLUETOOTH connection automatically.

Compatible smartphones

NFC-compatible smartphones with Android™ 4.1 or later installed

Note

- Depending on your NFC-compatible BLUETOOTH device, you may need to turn on the NFC function in advance. For details, refer to the operating instructions of the BLUETOOTH device.

- 1 Touch the BLUETOOTH device to the N-Mark on the system until the BLUETOOTH device responds to the system.**



Complete the connection by following the instructions displayed on the BLUETOOTH device. When the BLUETOOTH connection is established, the BLUETOOTH device name appears on the display.

- 2 Start playback of an audio source on the BLUETOOTH device.**

For details, refer to the operating instructions of your BLUETOOTH device.

To terminate the BLUETOOTH connection

Touch the BLUETOOTH device to the N-Mark on the system again.

Hint

- If pairing and the BLUETOOTH connection fail, do the following:
 - Remove the case from the BLUETOOTH device if using a commercially available case.
 - Touch the BLUETOOTH device to the N-Mark on the system again.

Home Audio System
MHC-V73D

Connecting this system with multiple BLUETOOTH devices (Multi-device connection)

Up to 3 BLUETOOTH devices can be connected to the system at the same time. You can switch the output among the connected devices.



- 1 To pair with a second or third device, repeat steps 1 to 3 of [Pairing and connecting with BLUETOOTH devices](#).

To switch the playback source

While playing back music on a device, if you start playback on another connected device, the system outputs sound from the newly playback device.

To disconnect any BLUETOOTH device from a multi-device connection

Terminate the BLUETOOTH connection on the BLUETOOTH device that you want to disconnect.

To disconnect all BLUETOOTH devices from a multi-device connection

Touch BLUETOOTH/  PAIRING on the system.

Note

- Operations may vary depending on the BLUETOOTH devices. A BLUETOOTH device may not be connectable depending on the combination of devices. For details, refer to the operating instructions of the devices.
- If you try to connect a 4th BLUETOOTH device, the oldest playback device will be disconnected.
- Depending on the BLUETOOTH devices, you may not be able to make three BLUETOOTH connections at the same time.
- You cannot establish a multi-device connection when using the Wireless Party Chain function or Stereo Pair function.

Related Topic

- [Pairing and connecting with BLUETOOTH devices](#)

Home Audio System
MHC-V73D

Listening to music of a device via BLUETOOTH connection

You can enjoy listening to music of a BLUETOOTH device and operate it by the system via BLUETOOTH connection if it supports the following BLUETOOTH profiles.

A2DP (Advanced Audio Distribution Profile)

Enables you to enjoy high-quality audio contents wirelessly.

AVRCP (Audio Video Remote Control Profile)

Enables you to adjust the volume and operate to play, pause or skip to the beginning of the next/current track.

Operations may vary depending on the BLUETOOTH device. Refer also to the operating instructions supplied with the BLUETOOTH device.

Note

- Make sure beforehand that the volume on the BLUETOOTH device and system are set to a moderate level to avoid sudden loud sound output from the system.
Depending on the BLUETOOTH device, adjusting the volume of the system may not be possible on the BLUETOOTH device while playback on the device is stopped/paused.

1 Connect the system with the BLUETOOTH device.

The BLUETOOTH device name appears on the display when the BLUETOOTH connection is established. Once the system and the BLUETOOTH device are connected, you can control playback by pressing ► (play), || (pause), ■ (stop), ◀◀ (fast reverse), ▶▶ (fast forward), ◀◀ (previous), and ▶▶ (next).

2 Start playback on the BLUETOOTH device.

3 Adjust the volume by touching VOLUME +/- on the system or operating the BLUETOOTH device.

Note

- If the communication condition is poor, the BLUETOOTH device may react incorrectly to the operations on the system.
- Depending on the BLUETOOTH device, it may be necessary to adjust the volume or set the audio output setting on the connected device.
- Noise or sound interruption may occur depending on the BLUETOOTH device connected with the system, the communication environment or the usage environment.

Related Topic

- [Pairing and connecting with BLUETOOTH devices](#)
- [Terminating the BLUETOOTH connection \(After use\)](#)

Selecting the BLUETOOTH audio streaming playback quality (Codec)

You can enable AAC, LDAC or SBC codec reception from a BLUETOOTH device.
AAC/LDAC can be selected only when the BLUETOOTH device supports AAC/LDAC.

1 Press **OPTIONS**.

The options menu appears on the display.

2 Press **↑ (up)/ ↓ (down)** repeatedly to select **[BT CODEC]**, then press **⏏ (enter)**.

3 Press **↑ (up)/ ↓ (down)** repeatedly to select the setting, then press **⏏ (enter)**.

- [AUTO]: Enable reception in AAC or LDAC codec format depending on the BLUETOOTH device's capabilities.
- [SBC]: Receive in SBC codec format.

To exit the options menu, press **OPTIONS**.

Hint

- LDAC is an audio coding technology developed by Sony that enables the transmission of High-Resolution (Hi-Res) Audio content, even over a BLUETOOTH connection. Unlike other BLUETOOTH compatible coding technologies such as SBC, it operates without any down-conversion of the Hi-Res Audio content^{*1}, and allows approximately three times more data^{*2} than those other technologies to be transmitted over a BLUETOOTH wireless network with unprecedented sound quality, by means of efficient coding and optimized packetization.

*1 Excluding DSD format contents.

*2 In comparison with SBC (Subband Codec) when the bitrate of 990 kbps (96/48 kHz) or 909 kbps (88.2/44.1 kHz) is selected.

Note

- You can enjoy high quality sound if AAC or LDAC is selected. If you cannot listen to AAC or LDAC sound from your device or the sound is interrupted, select [SBC].
- If you change this setting while the system is connected to a BLUETOOTH device, the BLUETOOTH device will be disconnected. To connect to the BLUETOOTH device, perform the BLUETOOTH connection again.

Related Topic

- [Using the BLUETOOTH standby function](#)

Home Audio System
MHC-V73D

Terminating the BLUETOOTH connection (After use)

- 1 Touch BLUETOOTH/  PAIRING on the system.

[BT AUDIO] appears on the display.

Note

- Depending on the BLUETOOTH device, the BLUETOOTH connection may be terminated automatically when you stop playback.

Related Topic

- [Turning the power on](#)
- [Auto Standby function](#)

Home Audio System
MHC-V73D

Turning on or off the BLUETOOTH signal

You can connect to the system from a paired BLUETOOTH device when the system's BLUETOOTH signal is set to on. At the time of purchase, this setting is set to on.

1 Hold down **MEGA BASS** and **MIC/GUITAR LEVEL +** on the system for about 3 seconds.

[BT ON] or [BT OFF] appears on the display.

Note

- You cannot perform the following operations when BLUETOOTH signal is set to off:
 - Pair and/or connect with BLUETOOTH device.
 - Use “Sony | Music Center.”
 - Change the BLUETOOTH audio codecs.
- If you touch the N-Mark on the system with an NFC-compatible BLUETOOTH device or set the BLUETOOTH standby mode to on, the BLUETOOTH signal will be set to on automatically.

Home Audio System
MHC-V73D

Using the BLUETOOTH standby function

The BLUETOOTH standby mode enables the system to turn on automatically when you establish a BLUETOOTH connection from a BLUETOOTH device. At the time of purchase, this setting is set to off.

- 1 Press **OPTIONS**.
- 2 Press **↑ (up)/ ↓ (down)** repeatedly to select **[BT STBY]**, then press **⏏ (enter)**.
- 3 Press **↑ (up)/ ↓ (down)** repeatedly to select the setting, then press **⏏ (enter)**.
 - **[ON]**: The system turns on automatically even when the system is in standby mode.
 - **[OFF]**: Off.

To exit the options menu

Press **OPTIONS**.

Related Topic

- [Pairing and connecting with BLUETOOTH devices](#)

Home Audio System
MHC-V73D

Listening to FM radio

Before listening to the FM radio, you need to connect the FM lead antenna (aerial) (supplied) to the FM ANTENNA terminal on the system and tune into an FM station which you want to listen to.

- 1 **Connect the FM lead antenna (aerial) to the FM ANTENNA terminal on the system.**

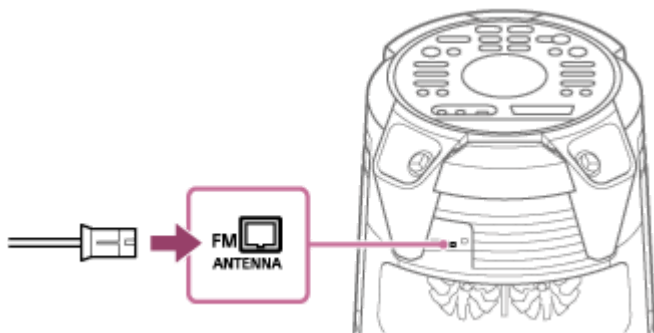

Extend the antenna (aerial) horizontally. Keep the antenna (aerial) away from the AC power cord (mains lead) and the USB cable to avoid picking up noise.

- 2 **Press FUNCTION repeatedly to select [TUNER FM].**
- 3 **Hold down TUNING +/- until the frequency begins to change on the display.**

Scanning stops automatically when the system tunes into a station. [ST] (for FM stereo programs only) lights up on the display. If scanning does not stop, press ■ (stop) to stop scanning. Then, perform manual tuning (below).

For manual tuning

Press TUNING +/- repeatedly to tune into the station which you want to listen to.

Hint

- To reduce static noise on a weak FM stereo station, press REPEAT/FM MODE repeatedly until [ST] lights off on the display. You will lose the stereo effect, but reception will improve.

Note

- When you tune into an FM station that provides RDS services, information such as the service name or station name is provided by broadcasts. You can check the RDS information by pressing DISPLAY repeatedly.

Related Topic

- [Presetting radio stations](#)

Home Audio System
MHC-V73D

Presetting radio stations

You can store up to 20 FM stations as your favorite stations.

- 1 Tune into a station you want to preset. (See [Listening to FM radio.](#))
- 2 Press DVD/TUNER MENU.
- 3 Press **▲** (up)/ **▼** (down) repeatedly to select the preset number you want, then press **□** (enter).

[COMPLETE] appears on the display and the station is stored.

If another station is already assigned to the selected preset number, that station is replaced by the new one.

To listen to the preset station

Press PRESET +/- repeatedly to select the preset number you want. Alternatively, hold down SHIFT and press the numeric buttons, then press **□** (enter).

Home Audio System
MHC-V73D

Enjoying wireless playback using multiple audio systems (Wireless Party Chain function)

By connecting multiple devices compatible with the Wireless Party Chain function, you can liven up parties with loud volume.

The first system in the chain to be activated becomes the Party Host and shares music with other systems (Party Guests).

Compatible devices:

Refer to <https://www.sony.net/smcqa/>.

Before operating the system, make sure that all systems to be connected within 1 m (3.2 ft) of the device.

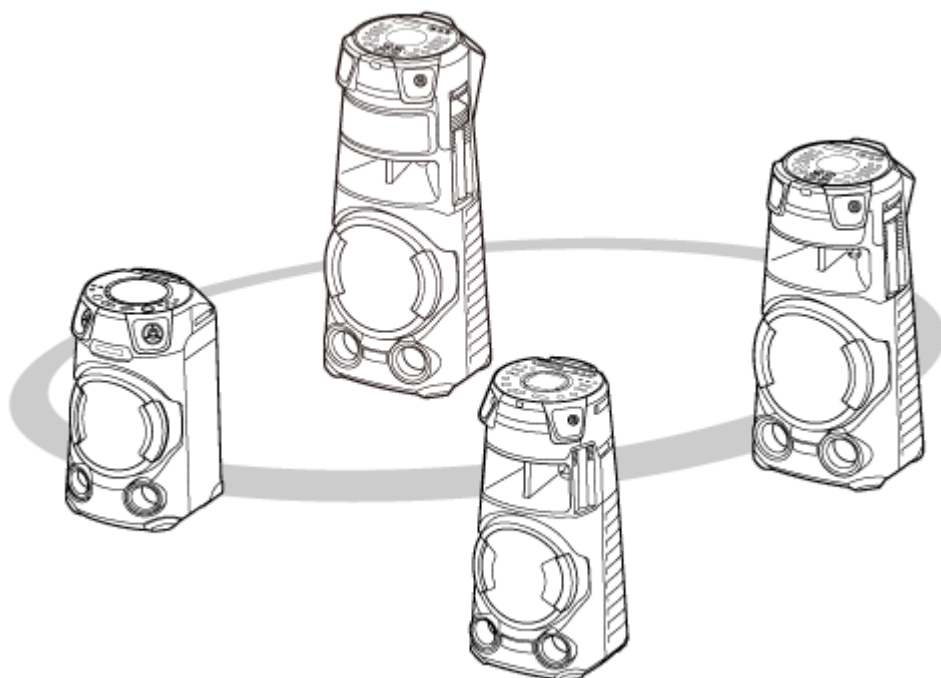

1 Activate the BLUETOOTH function on all systems.

The following operation is an example of activating the BLUETOOTH function on MHC-V73D. Refer to the operating instructions supplied with the device you are using to set up other devices compatible with the Wireless Party Chain function.

1. Press  (power) to turn on the system.
2. Press FUNCTION repeatedly until [BLUETOOTH] appears on the display.

2 Set up the first system as the Party Host.

The following operation is an example of setting MHC-V73D as the first system. Refer to the operating instructions supplied with the device you are using to set up other devices compatible with the Wireless Party Chain function.

1. Make sure that [BT AUDIO] is displayed on the display.
If not, perform step .

2. Connect the BLUETOOTH device to the system via BLUETOOTH connection.

For details, see [Pairing and connecting with BLUETOOTH devices](#).

When the BLUETOOTH device name appears on the display, the BLUETOOTH connection is established.

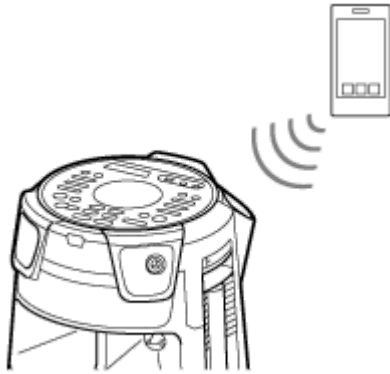

3. Touch WIRELESS PARTY CHAIN on the system.

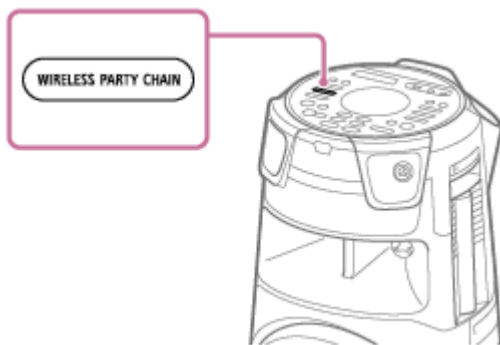

[CHAINING] flashes on the display.

The connection to the BLUETOOTH device is terminated automatically once the system enters the Wireless Party Chain Setup mode.

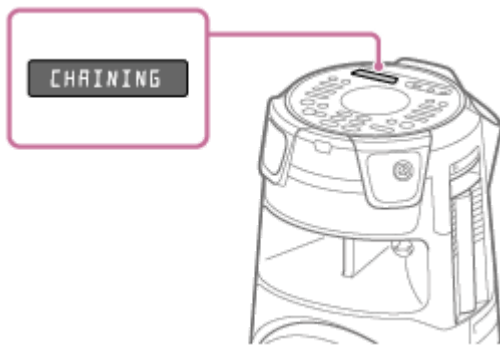

3 Connect a second or subsequent system as a Party Guest.

The following operation is an example of connecting MHC-V73D as the second or subsequent system. Refer to the operating instructions supplied with the device you are using to connect other devices compatible with the Wireless Party Chain function.

1. Make sure that [BT AUDIO] is displayed on the display of the second or subsequent system.
If not, perform step ①.
2. Touch WIRELESS PARTY CHAIN on the second or subsequent system.

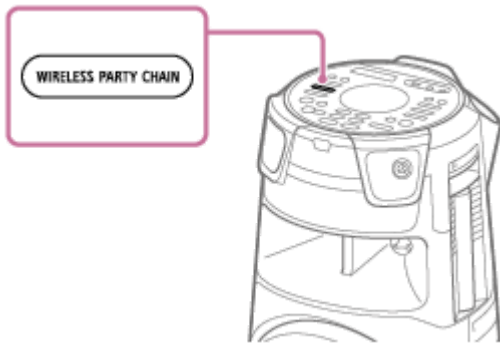

Hint

- Connect the second system within 1 minute. After 1 minute or more, the system setting is canceled.

[HOST] appears on the display of the first system.

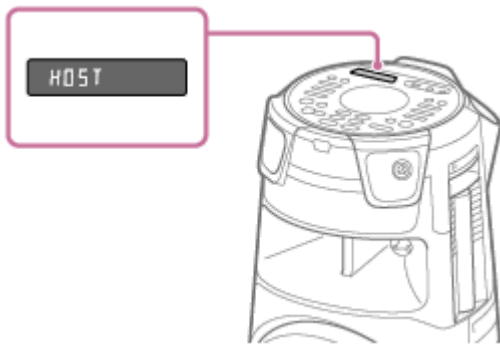

[GUEST XX]* appears on the display of the second or subsequent system.

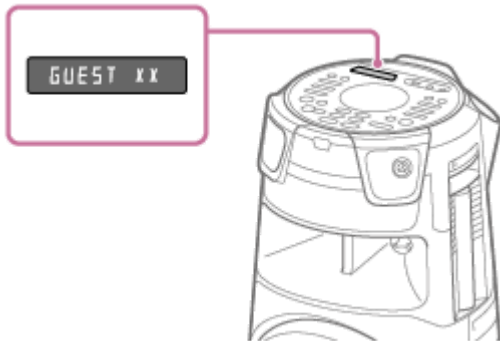

* XX indicates the number that is assigned to the device connected as the Party Guest.

3. To connect additional systems, repeat steps ③ – 1 and ③ – 2.

Hint

- When connecting a third or subsequent systems, connect each one within 30 seconds of connecting the previous system. After 30 seconds or more, the system cannot be connected.
- If you want to add another system after connecting (30 seconds or more), hold down WIRELESS PARTY CHAIN on the first system, then operate steps ③ – 1 and ③ – 2.

4 Wait 30 seconds after the last Party Guest is connected.

[P.CHAIN] stops flashing on the display of the Party Host and the BLUETOOTH device reconnects to the Party Host.

5 Start playback on the BLUETOOTH device.

Start playback on the connected BLUETOOTH device and adjust the volume.

The same music is played from all systems.

When adjusting the volume on the BLUETOOTH device or the Party Host, the volumes of the Party Guests are automatically adjusted.* For the Party Guests, you can also adjust the volume on each other.

* Depending on the connected device, the volume may not be synchronized with the volume you adjusted on the Party Host.

Synchronization of settings in a Wireless Party Chain

When a Wireless Party Chain has been established, the following settings on the Party Host and Party Guests are changed:

- The MEGA BASS settings on Party Guests are synchronized with the Party Host.
- The Karaoke setting (Vocal Fader, Key Control and Mic Echo) on both Party Host and Party Guests is turned off.
- The Party Light settings on the Party Guests are synchronized with the Party Host.
- DJ Effect on both the Party Host and Party Guests is turned off.
- The sound field settings return to the defaults on both Party Host and Party Guests.
- When the volume on the Party Host is adjusted, the volume on the Party Guests is synchronized with the volume on the Party Host. However, even if the volume on the Party Guest is adjusted, the volume on the Party Host will not change.
- When the Party Host is turned off, the Party Guests also turn off.

Hint

- You can also operate the Wireless Party Chain function on “Sony | Music Center.”
- What you can do with the Wireless Party Chain function depends on the systems you connect.
- When using the Wireless Party Chain function, the codec automatically switches to SBC.

Note

- When watching movies using the Wireless Party Chain function, there may be a delay between video and audio.
- The Wireless Party Chain function is available only when the system is in BLUETOOTH function.
- When you use the Wireless Party Chain function by connecting multiple types of audio systems, the lighting may not work depending on the order of the systems you connected. In this case, set the system whose lighting does not work as the Party Host.
- While the Wireless Party Chain function is active, you cannot select another system as a new Party Host.
- When you use the microphone or play a guitar on the Party Host, the sound is not output from the Party Guests.
- Sleep Timer and the Auto Standby function do not work on the Party Guests.

Related Topic

- [Terminating the Wireless Party Chain function](#)

Home Audio System
MHC-V73D

Terminating the Wireless Party Chain function

To terminate all connections and exit the Wireless Party Chain function

- 1 Touch WIRELESS PARTY CHAIN on the Party Host.

To terminate only one system

Touch WIRELESS PARTY CHAIN on the Party Guest you want to leave.

Note

- When you switch to a different function or turn off the Party Host, the Wireless Party Chain function is also terminated.

Home Audio System
MHC-V73D

Listening to music wirelessly with two systems (Stereo Pair function)

To use this function, two same model systems are required. By connecting two systems via BLUETOOTH connection, you can enjoy music in a more powerful way.

In the following steps, the two systems are described as “Host system” and “Guest system.”

Note

- To use this function, make sure “Sony | Music Center” has been installed to your BLUETOOTH device.
- Be sure that the BLUETOOTH device has paired with both Host system and Guest system. For details on the pairing operation, see the following topics.
 - [Pairing and connecting with BLUETOOTH devices](#)
 - [Connecting with an NFC-compatible device by One-touch \(NFC\)](#)

- 1 Place two systems of the same model within 1 m (3.2 ft) of each other.
- 2 Turn on Host system and Guest system.
- 3 Touch BLUETOOTH/  PAIRING on Host system and Guest system to select the BLUETOOTH function.
[BLUETOOTH] appears on the display.
- 4 Connect Host system and a BLUETOOTH device via BLUETOOTH connection. (See [Pairing and connecting with BLUETOOTH devices](#).)
- 5 Launch “Sony | Music Center” and follow the on-screen instructions to setup the Stereo Pair for Host system and Guest system.
[HOST] appears on the display of Host system, and [GUEST] appears on the display of Guest system.
- 6 Set the output mode using “Sony | Music Center” on your BLUETOOTH device.
 - [Stereo mode - right]: Outputs the monaural sound of the right channel from Host system, and the left channel from Guest system.
 - [Stereo mode - left]*: Outputs the monaural sound of the left channel from Host system, and the right channel from Guest system.

* Default setting
- 7 Start playback on the BLUETOOTH device and adjust the volume.
For details, see [Listening to music of a device via BLUETOOTH connection](#).

Synchronization of settings with Stereo Pair

- When a Stereo Pair connection has been established, the following settings on the Guest system are synchronized with those on the Host system:
 - Volume
 - MEGA BASS
 - Sound field and Custom EQ
 - DJ Effect
 - Lighting
- When the settings above are changed on either Host system or Guest system, the settings on the other system are synchronized.
- When Host system is turned off, Guest system also turns off.

To deactivate the Stereo Pair function

Use “Sony | Music Center” and follow the on-screen instructions.

Hint

- If you do not deactivate the function, the system will try to re-establish the most recent connection the next time you turn on the system.
- Switch to SBC codec when using the Stereo Pair function. For details, see [Selecting the BLUETOOTH audio streaming playback quality \(Codec\)](#).

Note

- When you use the microphone or play the guitar on Host system, the sound will not be output from Guest system.
- The following operations do not work on Guest system when using Stereo Pair:
 - Sleep Timer
 - Auto Standby
 - Child Lock
 - Party Lock
 - Gesture Control
 - Vocal Fader, Key Control, and Score Mode
 - Controlling the system using the remote control
- If you reset one of the two systems while using the Stereo Pair function, make sure to turn off the other system.

Related Topic

- [Installing “Sony | Music Center”](#)

Home Audio System
MHC-V73D

Reinforcing bass sound and creating more powerful sound (MEGA BASS)

You can reinforce bass sound and listen to more powerful sound (MEGA BASS). At the time of purchase, the MEGA BASS mode is set to on.

- 1 Press MEGA BASS repeatedly to select [BASS ON].

The MEGA BASS indicator lights up.



To turn off the MEGA BASS mode

Press MEGA BASS repeatedly to select [BASS OFF].

Hint

- You can also use "Sony | Music Center" to turn on/off the MEGA BASS mode.

Home Audio System
MHC-V73D

Selecting a sound field

You can adjust the sound by selecting a sound field.

- 1 Press **SOUND FIELD +/-** (or touch **SOUND FIELD** on the system) repeatedly to select the sound field you want.

To cancel the sound field

Press **SOUND FIELD +/-** (or touch **SOUND FIELD** on the system) repeatedly to select [FLAT].

To select FIESTA sound field directly

Touch **FIESTA** on the system. This setting reproduces the sound effect of a party hall.

To select the Virtual Football mode

You can experience the feeling of being in the stadium when watching a football match broadcast.

Note that you can only select the Virtual Football mode during **AUDIO IN** and **TV** functions.

Press **SOUND FIELD +/-** (or touch **SOUND FIELD** on the system) repeatedly while watching a football match broadcast.

- [ON NARRATION]: You can enjoy an immersive feeling of being in a football stadium through enhanced stadium cheers.
- [OFF NARRATION]: You can enjoy a more immersive feeling of being in a football stadium by minimizing the volume level of narration in addition to the enhancement of cheers.

Note

- If you hear unnatural sounds in the content when [OFF NARRATION] is selected, [ON NARRATION] is recommended.
- This feature does not support monaural sound.

To create your own sound effect

You can raise or lower the levels of specific frequency bands, then store the setting in the memory as [CUSTOM EQ].

1. Press **OPTIONS**.
The options menu appears on the display.
2. Press **▲** (up)/ **▼** (down) repeatedly to select [CUSTOM EQ], then press **⏏** (enter).
3. Press **▲** (up)/ **▼** (down) repeatedly to adjust the equalizer level or surround setting, then press **⏏** (enter).
4. Repeat step 3 to adjust the level of other frequency bands and surround effect.
To exit the options menu, press **OPTIONS**.

To select the custom equalizer setting

Press **SOUND FIELD +/-** (or touch **SOUND FIELD** on the system) repeatedly to select [CUSTOM EQ].

Related Topic

Home Audio System
MHC-V73D

What you can do with “Sony | Music Center”

“Sony | Music Center” is an app for controlling Sony audio devices which are compatible with “Sony | Music Center” using your smartphone/iPhone.

For details about “Sony | Music Center,” refer to the following URL:

<https://www.sony.net/smcqa/>

Operations that can be performed on the system with “Sony | Music Center”

- Changing functions of the system
- Browsing music content of a disc and USB device
- Viewing information of a disc, USB device, and FM station
- Adjusting the volume
- Controlling the playback of a source in smartphone or iPhone
- Controlling the playback of a disc and USB device
- Tuning into an FM station and presetting the stations
- Changing sound settings, DJ Effect, and MEGA BASS
- Setting the Sleep Timer
- Setting the lighting mode
- Grouping with other audio systems (Stereo Pair function / Wireless Party Chain function)

, etc.

Hint

- What you can control with “Sony | Music Center” varies depending on the connected device. The specifications and design of the app may change without notice.
- Be sure to use the latest version of the app.

Note

- If “Sony | Music Center” does not work properly, touch BLUETOOTH/  PAIRING on the system to terminate the BLUETOOTH connection, then perform the BLUETOOTH connection again so that the BLUETOOTH connection functions normally.

Related Topic

- [Installing “Sony | Music Center”](#)

Home Audio System
MHC-V73D

Installing “Sony | Music Center”

Install “Sony | Music Center” on your smartphone, iPhone, etc. from the App Store or on Google Play.

- 1 Download “Sony | Music Center” on Google Play or the App Store and install it.



Sony Music Center



- 2 When the installation is complete, launch “Sony | Music Center.”

Hint

- Depending on your contract, downloading the app may require communication charges.

Related Topic

- [What you can do with “Sony | Music Center”](#)

Home Audio System
MHC-V73D

What you can do with “Fiestable”

“Fiestable” is an app for operating Sony audio devices compatible with “Fiestable” from smartphones, iPhone, etc.

Operations that can be performed on the system with “Fiestable”

- DJ Control
You can add more DJ Effects and sampler sound to the source played back on the system.
- Illumination
You can control lighting of the system with more settings.
- Karaoke
You can activate various Karaoke features.
- Motion Control
You can operate the system by shaking the smartphone, iPhone, etc.
- Voice Control
You can operate the system by speaking preset voice commands into smartphone/iPhone microphone.
- Party Light
You can synchronize the screen illumination of multiple smartphones/iPhone with the lighting of this system.
- Party People ranking
You are ranked based on the usage frequency of the system.
- Karaoke Ranking
You can sing Karaoke and compete with others to achieve top 10 ranking.
- Taiko Game Ranking
You can play the Taiko game and compete with others to achieve top 10 ranking.
- Party Playlist
You and your guests can add favorite songs to a playlist from multiple BLUETOOTH devices.

Hint

- What you can control with “Fiestable” varies depending on the connected device. The specification and design of the app may change without notice.
Be sure to use the latest version of the app.

Related Topic

- [Installing “Fiestable”](#)

Home Audio System
MHC-V73D

Installing “Fiestable”

Install “Fiestable” on your smartphone, iPhone, etc. on Google Play or the App Store.

- 1 Download “Fiestable” on Google Play or the App Store and install it.



- 2 When the installation is completed, launch “Fiestable” from the “Sony | Music Center” screen.

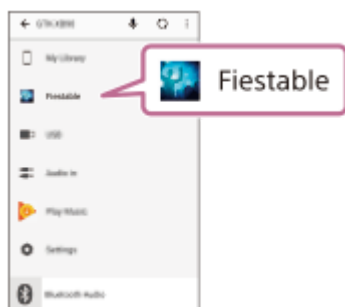

Related Topic

- [Installing “Sony | Music Center”](#)
- [What you can do with “Fiestable”](#)

Home Audio System
MHC-V73D

Using the DJ Effect and sampler

You can add a DJ Effect and a sampler sound to a music source.

- 1 Establish a BLUETOOTH connection between the system and your smartphone/iPhone.**
- 2 Launch “Sony | Music Center” and touch the “Fiestable” icon.**
- 3 Touch [DJ Control].**
A list of the DJ Effects appears at the top of the screen and the sampler list appears at the bottom.
- 4 Touch any of the DJ Effects or the sampler icons.**
You can create a fun DJ Effect or output a sampler sound by moving your finger inside the outlined area.

To turn off the DJ Effect

Touch [DJ Off].

Personalizing your own lighting

You can specify the pattern and color of lighting to create your own lighting by using “Fiestable.”

- 1 Establish a BLUETOOTH connection between the system and your smartphone/iPhone.**
- 2 Launch “Sony | Music Center” and touch the “Fiestable” icon.**
- 3 Touch [Illumination].**
A list of the lighting patterns and the color palette appear on the app screen.
- 4 Touch any of the lighting patterns.**
You can change the lighting color and the speed of flashing by moving your finger on the color palette.

Achieving and sharing a Party People ranking and getting bonus features (Party King)

The system has a unique feature that automatically records your system usage.

Based on your usage, the system will rank you a Party People ranking according to predefined criteria. The more frequently you use the system, the higher a ranking you will achieve.

Once you have achieved a certain Party People ranking, you can share your achievement through social media.

The system will also award your achievements with bonus features.

Note

- To use this feature, make sure “Sony | Music Center” and “Fiestable” have been installed on your device.

1 Establish a BLUETOOTH connection between the system and your device.

2 Launch “Sony | Music Center” and touch the “Fiestable” icon.

You can check your current ranking, explore bonus features and also find out how to achieve next ranking.

Related Topic

- [Installing “Sony | Music Center”](#)
- [Installing “Fiestable”](#)
- [Pairing and connecting with BLUETOOTH devices](#)

Home Audio System
MHC-V73D

Using Voice Control via “Fiestable”

You can operate the system by speaking preset voice commands that appear on your smartphone/iPhone screen.

Note

- Supported languages are as follows:
English/Brazilian Portuguese/French/German/Italian/Polish/Russian/Spanish
- If your smartphone/iPhone is set to an unsupported language, the list of preset voice commands will be displayed in English.

1 Establish a BLUETOOTH connection between the system and your smartphone/iPhone.

Make sure your smartphone/iPhone is connected to the Internet.

2 Launch “Sony | Music Center” and touch the “Fiestable” icon.

3 Touch [Voice Control via Fiestable].

The preset voice commands appear on the app screen.

4 Touch the microphone icon on the app screen.

The system is muted. Speak into the microphone of your smartphone/iPhone. Your voice will be sent to an online speech to text conversion service. When the conversion completes, the command will be sent back to the system. Muting is canceled and the system will respond according to the command.

Note

- The Voice Control via “Fiestable” does not work in the following cases:
 - The built-in sound demonstration is turned on.
 - When you open the disc tray.
 - During USB transfer or erase operations.
 - When the online speech to text conversion service is not available, terminated or the connection failed.
 - When your smartphone/iPhone microphone is being used by other application.
 - During the Taiko game.

Related Topic

- [Pairing and connecting with BLUETOOTH devices](#)

Creating party lighting atmosphere via “Fiestable”

You can synchronize the screen illumination and flash light of multiple smartphones/iPhone using this function.

- 1 Turn on the lighting of the system.
- 2 Start playing the music.
- 3 Turn on the BLUETOOTH function on your smartphone/iPhone.

Note

- BLUETOOTH connection is not required unless you are using multiple systems. If you want to synchronize your smartphone/iPhone with a specific system, establish a BLUETOOTH connection between your smartphone/iPhone and that system. Otherwise, proceed to step 4 and your smartphone/iPhone will synchronize with the nearest system.
- Make sure to turn on the location service on your smartphone/iPhone.

- 4 Launch “Fiestable” and touch “Party Light via Fiestable.”

All smartphone/iPhone screen illumination and flash light flash synchronously.

Related Topic

- [Enjoying music with the lighting \(Party Light/Speaker Light\)](#)
- [Singing and competing in Karaoke \(Karaoke Ranking\)](#)
- [Creating playlist from multiple BLUETOOTH devices \(Party Playlist\)](#)

Home Audio System
MHC-V73D

Singing and competing in Karaoke (Karaoke Ranking)

You only can use the scoring function (Score mode) when the microphone is connected. Your score is calculated from a scale of 0 to 99 by comparing your voice with the music source.

- 1 **Establish a BLUETOOTH connection between the system and your smartphone/iPhone.**
- 2 **Launch “Sony | Music Center” and touch the “Fiestable” icon.**
- 3 **Touch [Karaoke].**
- 4 **Touch [Scoring Start].**
- 5 **Start playing the music on the system and sing a song.**
- 6 **Touch [Mic Level], [Echo], [Key Control], or [Vocal] on the app screen and adjust the slider to change the microphone volume level, echo intensity, pitch, or vocal/non-vocal setting in accordance with your preferences.**
- 7 **After singing for more than a minute, touch [Scoring Stop] to view your score.**

Your score will be shown on the app screen. If your score is in the top 10 ranking, the app will prompt you to input your name and song name. You can enter up to 16 alphanumeric characters for the player name and up to 24 alphanumeric characters for the song name.
Then, your ranking will be displayed.
The song name may be automatically extracted from the source if you play the source from smartphone apps.

To reset the ranking

Touch the Ranking icon on the app screen.

The Ranking list appears. Touch the reset icon to reset the list.

Note

- If your score is 0, it will not be ranked.
- The Karaoke Ranking does not work in the following cases:
 - When the microphone is not connected to the system.
 - If the system is in the Taiko mode.
- The Karaoke Ranking is automatically turned off when:
 - You disconnect the microphone from the system.
 - You press TAIKO on the system.

— You press FUNCTION to change the function.

5-014-121-11(2) Copyright 2020 Sony Corporation

Home Audio System
MHC-V73D

Creating playlist from multiple BLUETOOTH devices (Party Playlist)

Party Playlist is a function that continuously plays songs favorited by guests on their smartphone in the order they were registered.

- 1 Establish a BLUETOOTH connection between the system and your smartphone/iPhone.
- 2 Make sure your smartphone/iPhone is connected to a Wi-Fi network.
- 3 Launch “Sony | Music Center” and touch the “Fiestable” icon.
- 4 Touch [Party Playlist].
- 5 Follow the on-screen instructions.

To add songs to the playlist by the second and subsequent guests

1. Make sure your guests' smartphones/iPhone are connected to the same Wi-Fi network.
2. Launch “Sony | Music Center” and touch the “Fiestable” icon.
3. Follow the on-screen instructions.

Note

- Be sure to use the Party Playlist function on a secure Wi-Fi network.

Competing in the Taiko game (Taiko Game Ranking)

You can play the Taiko game and compete with other players to achieve top 10 ranking.

- 1 Establish a BLUETOOTH connection between the system and your smartphone/iPhone.**
- 2 Launch “Sony | Music Center” and touch the “Fiestable” icon.**
- 3 Touch [Taiko Game Ranking].**

The current leaderboard is displayed on the smartphone/iPhone screen.
- 4 Touch [Play] and start playing the Taiko game.**

Perform Step 2 and 3 of “Playing the Taiko game” in [Playing the drum \(Taiko\)](#).
Once the game is completed, your score will be shown on the smartphone/iPhone screen. If your score is in the top 10 ranking, the app will prompt you to input your name. The name is limited to only 16 alphanumeric characters. Then, your ranking will be displayed.

To reset the ranking

Touch [RESET] on the app screen.

Note

- If you activate the Taiko game using the TAIKO on the system, your score will not be recorded in the ranking.
- If your score is 0, it will not be ranked.
- The Taiko Game Ranking does not work in the following cases:
 - If you activate the Taiko game using the TAIKO on the system.
 - When you open the disc tray.
 - During USB transfer or erase operations.
- The Taiko Game Ranking is automatically turned off when:
 - You press TAIKO on the system.
 - BLUETOOTH connection is disconnected.
 - You receive an incoming call.

Related Topic

- [Playing the drum \(Taiko\)](#)

Home Audio System
MHC-V73D

Controlling the operations using Gesture Control

You can control the operations by swiping your hand over the GESTURE CONTROL sensor on the system.

- 1 Touch GESTURE ON/OFF on the system to select the gesture mode (GESTURE 1/GESTURE 2).**
 - [GESTURE1]:
Gesture controls for PLAYBACK, DJ, SAMPLER and KARAOKE mode
 - [GESTURE2]:
Gesture controls for the key of music source or your voice when you sing into the microphone
- 2 When the system is in GESTURE 1 mode, touch PLAYBACK, DJ, SAMPLER, or KARAOKE on the system to select the mode.**

If the system is in PLAYBACK mode, touch FUNCTION on the system repeatedly to select the function you want.
- 3 Swipe your hand over the GESTURE CONTROL sensor.**

To deactivate the Gesture Control

Touch GESTURE ON/OFF on the system repeatedly to select [OFF].

Note

- Do not touch or contact to the GESTURE CONTROL sensor when you perform the swiping motion.
- The DJ Effect is automatically turned off when you:
 - deactivate the Gesture Control.
 - change the mode to PLAYBACK/SAMPLER/KARAOKE.
 - turn off the system.
 - change the function.
 - activate or deactivate the Wireless Party Chain function.
 - change the sound field.
 - use the Vocal Fader.
 - change the key (Key Control).
- If you activate the DJ Effect during transferring, the sound effect will not be transferred onto the USB device.
- Do not touch or contact to the GESTURE CONTROL sensor when you move your hand up or down over it.
- None of the motions in GESTURE 1 mode works in GESTURE 2 mode.
- The GESTURE 2 mode is automatically turned off when you:
 - activate the Taiko mode.
 - change the mode to PLAYBACK/SAMPLER/KARAOKE/DJ.

– turn on the DJ Effect.

– turn on the guitar mode. *1

– select FIESTA/MOVIE1/MOVIE2/DRAMA/NEWS/GAME sound field. *2

– turn on Virtual Football mode. *2

– turn off the system.

– change the function.

● The key of your voice or the music returns to default when you move your hand away from the GESTURE CONTROL sensor.

*1 During MIC PITCH CONTROL mode only.

*2 During MUSIC PITCH CONTROL mode only.

Related Topic

- [Using Gesture Control to operate playback, DJ Effect, sampler, and karaoke \(GESTURE 1\)](#)
- [Using Gesture Control to control the key of your voice or music source \(GESTURE 2\)](#)

5-014-121-11(2) Copyright 2020 Sony Corporation

Home Audio System
MHC-V73D

Using Gesture Control to operate playback, DJ Effect, sampler, and karaoke (GESTURE 1)

When the system is in GESTURE 1 mode, you can select from the following modes.

- PLAYBACK mode
- DJ mode
- SAMPLER mode
- KARAOKE mode

For PLAYBACK mode:

You can control basic playback when playing music from a disc, USB device, or BLUETOOTH device.

To	Swipe in this direction
Go backward	←
Go forward	→
Play	↑
Stop	↓
Increase volume	↶
Reduce volume	↷

For DJ mode:

You can select a DJ Effect to create a party atmosphere.

To	Swipe in this direction
Select FLANGER ^{*1}	←
Select ISOLATOR ^{*2}	→
Select WAH ^{*3}	↑
Select PAN ^{*4}	↓
Increase the level of the selected effect	↶
Reduce the level of the selected effect	↷

*1 Creates a deep flanging effect that is similar to the roar of a jet plane.

*2 Isolates a specific frequency band by adjusting the other frequency bands. For example, when you want to focus on vocals.

*3 Creates a special effect of "Wah-wah" sound by moving the frequency of a filter up and down automatically.

*4 Creates a feeling that the sound is moving around the speakers between left and right channels.

To turn off the DJ Effect

Swipe your hand over the GESTURE CONTROL sensor in the same direction as when you have selected the DJ Effect.

For SAMPLER mode:

You can output sampler sound effects installed on the system.

To	Swipe in this direction
"Come On!"	←
"Let's Go!"	→
Reggae Horn sound effect	↑
Phaser sound effect	↓
Scratch sound effect	↺
Audience sound effect	↻

To adjust the level of the sampler

1. Press OPTIONS.
2. Press ↑ (up)/ ↓ (down) repeatedly to select [SAMPLER], then press ⏏ (enter).
3. Press ↑ (up)/ ↓ (down) repeatedly to adjust the sampler sound level, then press ⏏ (enter).

For KARAOKE mode

You can operate the following karaoke features.

To	Swipe in this direction
Reduce the key of a song (♭ (flat))	←
Increase the key of a song (# (sharp))	→
Increase the microphone volume	↑
Reduce the microphone volume	↓
Output hand clapping sound	↺
Output booing sound	↻

Related Topic

- [Using Gesture Control to control the key of your voice or music source \(GESTURE 2\)](#)

Home Audio System
MHC-V73D

Using Gesture Control to control the key of your voice or music source (GESTURE 2)

When the system is in GESTURE 2 mode, you can change the key of a song you are playing or your voice through a microphone connected to the system.

When the microphone is not connected to the system:

You can change the key of the music source that being played.

To	Raise or lower your hand over the sensor
Reduce the key of the music source (b (flat))	↓
Increase the key of the music source (# (sharp))	↑

When the microphone is connected to the system:

You can change the key of the voice through the microphone.

To	Raise or lower your hand over the sensor
Reduce the key of the voice (b (flat))	↓
Increase the key of the voice (# (sharp))	↑

Related Topic

- [Using Gesture Control to operate playback, DJ Effect, sampler, and karaoke \(GESTURE 1\)](#)

Home Audio System
MHC-V73D

Deactivating the controls on the system for a short time (Party Lock)

You can deactivate the controls (except  (power)) on the system for 30 seconds to wipe the top panel. To use this function, make sure GESTURE 1 mode has been selected.

- 1 **Hold your hand above GESTURE CONTROL sensor on the system for more than 5 seconds.**

[PARTY LOCK ON] appears on the display.

To turn off the Party Lock function, hold your hand above GESTURE CONTROL sensor on the system for more than 5 seconds until [PARTY LOCK OFF] appears on the display.

Note

While the Party Lock function is applied, the top panel indications of the system are turned off.

Home Audio System
MHC-V73D

Singing karaoke

You can enjoy singing karaoke using the Karaoke function.

- 1 Press MIC LEVEL - (or touch MIC/GUITAR LEVEL - on the system) repeatedly to reduce the microphone volume level to a minimum level.**
- 2 Touch GUITAR on the system repeatedly to select [OFF].**
- 3 Connect a microphone (not supplied) to the MIC1 or MIC2/GUITAR jack on the system.**
Connect another optional microphone if you want to sing in duet.
- 4 Start playing the music and adjust the microphone volume.**
Press MIC ECHO repeatedly to adjust the echo effect.
- 5 Start singing along with the music.**

Note

- If howling occurs, the system will automatically reduce the microphone sound for a few seconds.
- If howling continues, do the following:
 - Move the microphone away from the system.
 - Change the direction of the microphone.
 - Press MIC LEVEL - (or touch MIC/GUITAR LEVEL - on the system) repeatedly.
 - Press MIC ECHO repeatedly to adjust the echo level.
- Microphone sound will not be transferred to the USB device during USB transfer.
- You cannot adjust the microphone volume level using  (volume) +/- (VOLUME +/- on the system). Press MIC LEVEL +/- (or touch MIC/GUITAR LEVEL +/- on the system) repeatedly to adjust the microphone volume level.
- When using the Wireless Party Chain or Stereo Pair function, sound from the microphone is only output from the system to which the microphone is connected.
- If the sound through the microphone is extremely loud, it may be distorted. Press MIC LEVEL - (or touch MIC/GUITAR LEVEL - on the system) repeatedly to reduce the microphone volume.

Related Topic

- [Using the mic holder\(s\)](#)
- [Various functions for karaoke](#)

Home Audio System
MHC-V73D

Various functions for karaoke

You can use various functions for karaoke.

Vocal Fader

You can reduce the sound of the vocal in stereo source.

To activate the Vocal Fader function

Press VOCAL FADER repeatedly (or hold down VOICE CHANGER/  VOCAL FADER on the system) to select [ON V , FADER].



To cancel the Vocal Fader function

Press VOCAL FADER repeatedly to select [OFF].

Key Control

You can change the key of a song you sing.

To change the key of a song

Press KEY CONTROL  (flat)/  (sharp) to suit your vocal range.

Score Mode

You only can use the scoring function (Score mode) when the microphone is connected. Your score is calculated from a scale of 0 to 99 by comparing your voice with the music source.

To score your singing

1. Start playing the music.
2. Press SCORE before singing a song.
3. After singing for more than a minute, press SCORE again to view your score.

Voice Changer

You can change your voice when you talk or sing into microphone.

To activate the Voice Changer function

Press VOICE CHANGER repeatedly to change your voice effect.

To cancel the Voice Changer function

Press VOICE CHANGER repeatedly to select [OFF].

Mic Echo

You can add the echo effect to your voice when you sing into microphone.

To add the echo effect

Press MIC ECHO repeatedly to adjust the echo effect.

Related Topic

- [Singing karaoke](#)

5-014-121-11(2) Copyright 2020 Sony Corporation

Home Audio System
MHC-V73D

Enjoying sound from a guitar

You can listen to sound from a guitar (not supplied) by connecting the guitar to the MIC2/GUITAR jack on the system. You can also play the guitar and sing along by connecting a microphone to the MIC1 jack on the system. Additionally, you can change the guitar's sound by selecting a guitar effect.

- 1 **Press MIC LEVEL - (or touch MIC/GUITAR LEVEL - on the system) repeatedly to reduce the guitar volume level.**
- 2 **Use an instrument cable (not supplied) to connect a guitar to the MIC2/GUITAR jack on the system.**
- 3 **Press GUITAR on the system repeatedly to select the guitar effect that you want to apply.**
 - [CLEAN]: Original guitar sound. Recommended for electric guitar or electro-acoustic guitar.
 - [O \ DRIVE]: Distorted sound similar to an overdriven guitar amplifier. Recommended for electric guitar.
 - [BASS]: Original guitar sound. Recommended for bass guitar.
- 4 **Start playing the guitar and adjust the guitar volume.**

The guitar sound is output from the system.

To turn off the guitar mode

Touch GUITAR on the system repeatedly to select [OFF].

Note

- Howling may occur when using electro-acoustic guitar with [O \ DRIVE] effect. Press MIC LEVEL - (or touch MIC/GUITAR LEVEL - on the system) repeatedly to reduce the guitar volume. Otherwise, change to the other guitar effect.
- Before disconnecting the guitar from the system, press MIC LEVEL - (or touch MIC/GUITAR LEVEL - on the system) repeatedly to reduce the guitar volume.

Home Audio System
MHC-V73D

Playing the drum (Taiko)

You can play a virtual drum by using the top panel of the system as a drum pad.

Note

- Tap the top panel using your hands gently. Do not use other items, such as a stick as it will scratch the surface of the top panel.
- The pressure you apply when tapping the top panel will not affect the volume level in the Taiko mode.
- When you activate the Taiko mode, the Taiko volume follows the current system's volume level.
- During the Taiko mode, the controls on the system are deactivated except  (power) and TAIKO. Use the buttons on the remote control to change the function or volume of the music source.



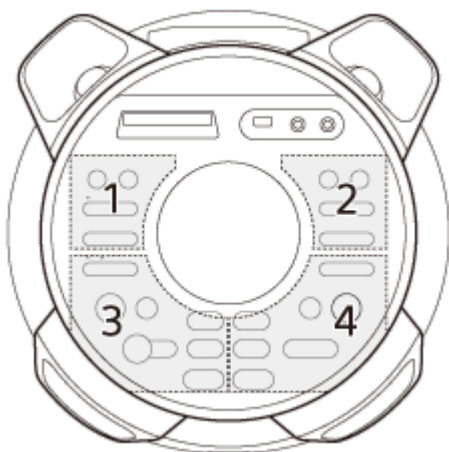

1 Press TAIKO on the system repeatedly to select [TAIKO].

The top panel lights up in 4 different colors according to zone.



2 Tap on zone 1, 2, 3 or 4 or swipe your hand over the GESTURE CONTROL sensor.

Available swiping motions:

- Right to left ()
- Left to right ()
- Bottom to top ()
- Top to bottom ()

3 Swipe your hand over the GESTURE CONTROL sensor in a clockwise () or counterclockwise () direction to adjust the drum sound volume.

Playing the Taiko game

In this game, you need to tap the top panel according to the lighting guide () pattern that appears on the surrounding of the GESTURE CONTROL sensor. Your score is calculated from a scale of 0 to 100 based on the number of correct

actions performed.

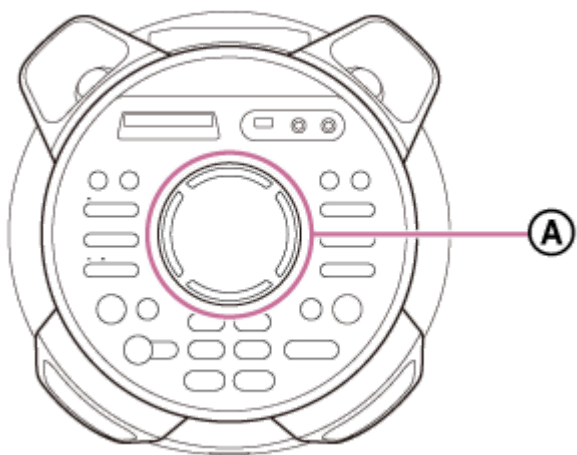

Ⓐ: Lighting guide

1. Press TAIKO on the system repeatedly until [GAME 5] flashes on the display.
The system counts down in 5 seconds and the game starts when [START] flashes on the display.

2. Tap zone 1, 2, 3 or 4 according to the lighting guide pattern.
The lighting guide will flash 3 times.

You need to tap the correct zone on the third time it flashes.

Tapping example for zone 4

1. Check the lighting guide which flashes in green pattern.

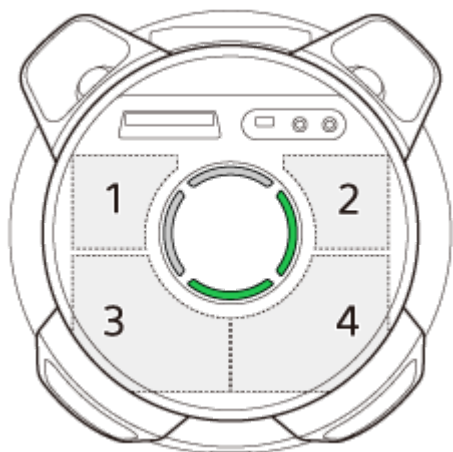



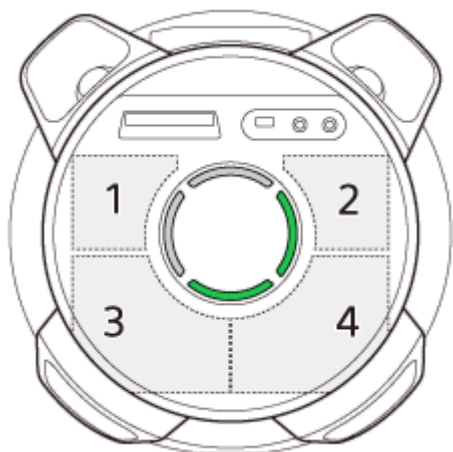

2. The lighting guide flashes once again in the same green pattern.

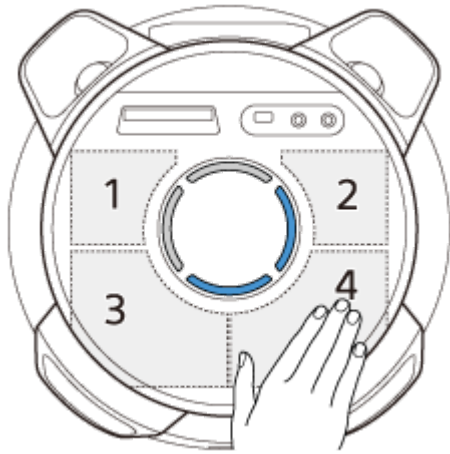

3. Tap the zone associated with the flashing lighting guide at the exact moment when the flashing color changes from green to blue.



Make sure you tap the correct zone at the exact moment when the lighting guide flashes in blue.

Lighting guide pattern	Zone you need to tap
	1
	2
	3
	4

- Continue to play the game for 50 seconds.
The score appears on the display after you completed the game.

To deactivate the Taiko game

Press TAIKO on the system repeatedly until the lighting guide lights off.

Related Topic

- [Competing in the Taiko game \(Taiko Game Ranking\)](#)

5-014-121-11(2) Copyright 2020 Sony Corporation

Home Audio System
MHC-V73D

Using the Sleep Timer

The system turns off automatically after the preset time.

- 1 Press **SLEEP** repeatedly to select the time you want.

To cancel Sleep Timer

Press **SLEEP** repeatedly to select [OFF].

Hint

- To check the remaining time before the system turns off, press **SLEEP**.

Enjoying music with the lighting (Party Light/Speaker Light)

The system lights up with the music to liven up the atmosphere. At the time of purchase, this setting is set to on.

1 Press PARTY LIGHT repeatedly during playback to select [LED ON].

The parts of the system illustrated below light up.

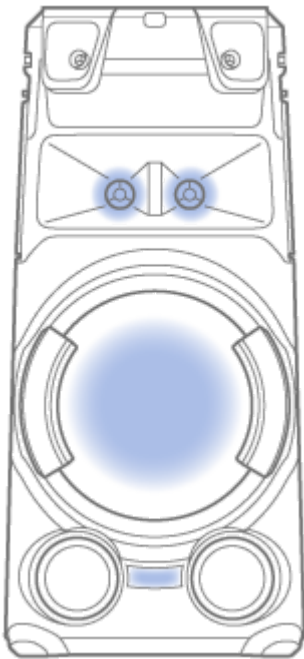

2 Press LIGHT MODE repeatedly to select the lighting mode you want.

The lighting mode is different when Wireless Party Chain or Stereo Pair function is activated.

To turn off the lighting

Press PARTY LIGHT repeatedly to select [LED OFF].

Note

- Do not look directly at the light-emitting part when the lighting is turned on.
- If the lighting brightness is glaring, switch on the room lights or turn off the lighting.
- You can turn on or off the lighting when the demonstration is turned on.

Related Topic

- [Turning off the demonstration mode](#)

Using the Voice Guidance

IMPORTANT: THE VOICE GUIDANCE FOR THIS SYSTEM IS ONLY AVAILABLE IN ENGLISH.

- 1 Press **OPTIONS**.
- 2 Press **↑ (up)/ ↓ (down)** repeatedly to select **[VOICE GUIDANCE]**, then press **⏎ (enter)**.
- 3 Press **↑ (up)/ ↓ (down)** to select **[ON]**, then press **⏎ (enter)**.

The Voice Guidance is activated.

To exit the options menu, press **OPTIONS**.

Depending on the status of the system, the Voice Guidance outputs from the system as follows:

- When setting the system to the pairing mode: "BLUETOOTH pairing"
- When connected to a BLUETOOTH device: "BLUETOOTH connected"
- When disconnected from a BLUETOOTH device: "BLUETOOTH disconnected"

To deactivate the Voice Guidance

Select **[OFF]** in step **3**.

To adjust the level of the Voice Guidance

1. Press **OPTIONS**.
2. Press **↑ (up)/ ↓ (down)** repeatedly to select **[SAMPLER]**, then press **⏎ (enter)**.
3. Press **↑ (up)/ ↓ (down)** repeatedly to adjust the Voice Guidance level, then press **⏎ (enter)**.
To exit the options menu, press **OPTIONS**.

Note

- The Voice Guidance volume level changes according to the system's volume level. However, in some cases, the Voice Guidance volume level may not change.
- In some cases, there may be a delay in Voice Guidance output or the Voice Guidance may not work.

Home Audio System
MHC-V73D

Deactivating the controls on the system (Child Lock)

You can deactivate the controls (except  (power)) on the system to prevent misoperation by children.

1 Hold down  (stop) on the system for more than 5 seconds.

[CHILD LOCK ON] appears on the display.

To turn off the Child Lock function

Hold down  (stop) on the system for more than 5 seconds until [CHILD LOCK OFF] appears on the display.

Note

- The Child Lock function will be turned off automatically when you disconnect the AC power cord (mains lead).
- The Child Lock function cannot be activated when the disc tray is opened.

Home Audio System
MHC-V73D

Listening to the built-in sound demonstration

Hold down ► (play) on the system for more than 2 seconds.
The built-in sound demonstration is played back.

To stop the demonstration



Touch ■ (stop) on the system.

Home Audio System
MHC-V73D

Settings menu

You can adjust various settings from the setup menu.

To enter the setup menu, hold down SHIFT and press SETUP when playback is stopped in the DVD/CD or USB function.

The setup menu appears on the TV screen. Please use  (up)/  (down) and  (enter) to navigate the setup menu.

To exit the menu, hold down SHIFT and press SETUP.

Displayed items vary depending on the country or region.

Note

- Playback settings stored in the disc take priority over the setup menu settings. Therefore, some of the setup menu settings may not be performed.



Setting the language – [LANGUAGE SETUP]

[OSD]	Sets the language of the on-screen display.
[MENU] (for DVD VIDEO)	Sets the language for the DVD menu.
[AUDIO] (for DVD VIDEO)	Switches the language of the sound track. When you select [ORIGINAL], the language given priority in the disc is selected.
[SUBTITLE] (for DVD VIDEO)	Switches the language of the subtitle. When you select [AUDIO FOLLOW], the language for the subtitles changes according to the language you selected for the sound track.

Note

- If you select [OTHERS →] in [MENU], [AUDIO], and [SUBTITLE], enter a language code using the numeric buttons.
For language code, see [Language code list](#).

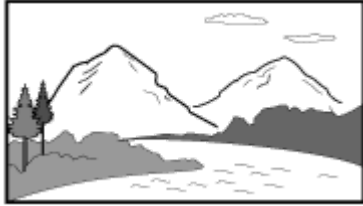
Setting the TV screen – [VIDEO SETUP]

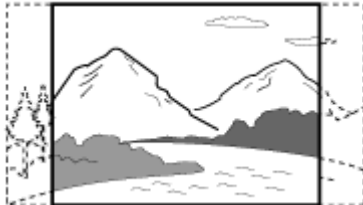
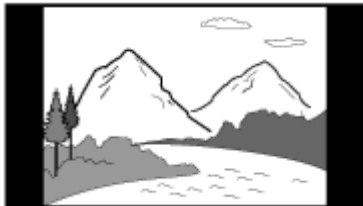
[TV TYPE] (for DVD VIDEO)	[16:9] ^{*1}	<p>Selects this when you connect a wide-screen TV or a TV with a wide-mode function.</p> 
	[4:3 LETTER BOX]	<p>Selects this when you connect a 4:3 screen TV that does not have a wide-mode function. Displays a wide picture with black bands on the top and bottom.</p> 
	[4:3 PAN SCAN]	<p>Selects this when you connect a 4:3 screen TV that does not have a wide-mode function. Displays a full-height picture on the entire screen, with trimmed sides.</p> 
[4:3 OUTPUT] (for DVD VIDEO)	[FULL] ^{*1}	<p>Selects this when you connect a TV with a wide-mode function. Displays a 4:3 screen picture in 16:9 aspect ratio even on a wide-screen TV.</p>
	[NORMAL]	<p>Changes the picture size to fit the screen size with the original picture aspect ratio. Displays black bands on the left and right side if you display a 4:3 screen picture.</p> 
[COLOR SYSTEM(VIDEO CD)] ^{*2} (for VIDEO CD) (Except for Latin American, Brazilian, European, and Russian models)	[AUTO] ^{*1}	<p>Outputs the video signal according to the color system of the disc. Select this setting if your TV uses a DUAL system.</p>
	[PAL]	<p>Outputs the video signal in PAL system.</p>
	[NTSC]	<p>Outputs the video signal in NTSC system.</p>

[PAUSE MODE] (for DVD VIDEO)	[AUTO] ^{*1}	The picture, including subjects that move dynamically, is output with no jitter. Normally select this setting.
	[FRAME]	The picture, including subjects that do not move dynamically, is output in high resolution.

*1 Default setting

*2 For details, see [Hooking up TV](#).

Setting the audio options – [AUDIO SETUP]

[AUDIO DRC] (for DVD VIDEO) (Dynamic Range Compression)	[OFF] [*]	Off.
	[STANDARD]	Selects this when watching movies at low volume late at night. The dynamic range is compressed as intended by the recording engineer.
[TRACK SELECTION] (for DVD VIDEO)	[OFF] [*]	No priority given.
	[AUTO]	Gives priority to the sound track which contains the highest number of channels when you play back a DVD VIDEO on which multiple audio formats (PCM, MPEG audio, or Dolby Digital) are recorded.
[A/V SYNC] DVD VIDEO/VIDEO CD/DATA CD/DATA DVD) (Video files only)	[OFF] [*]	Does not adjust.
	[ON]	Adjusts the delay between picture and sound when the sound does not synchronize with the displayed picture.
[DOWNMIX] (for DVD VIDEO)	[NORMAL] [*]	Outputs multi-channel audio into a 2-channel stereo signal.
	[DOLBY SURROUND]	Outputs multi-channel audio into a 2-channel surround signal.

* Default setting

Note

- [DOWNMIX] only works for the HDMI OUT (TV) ARC connector on the system.

Setting the system – [SYSTEM SETUP]

[SCREEN SAVER]	[ON] [*]	The screen saver image appears if you do not operate the system for about 15 minutes. Press  (volume) +/- (or touch VOLUME +/- on the system) to exit the screen saver.
	[OFF]	Off.
[BACKGROUND]	[JACKET PICTURE] [*]	The jacket picture (still picture) recorded on the disc appears in the background.
	[GRAPHICS]	A preset picture stored in the system appears in the background.
	[BLUE]	The background color is blue.
	[BLACK]	The background color is black.

[PARENTAL CONTROL]	Sets the playback restrictions. For details, see Restricting playback of the disc (Parental Control) .	
[MULTI-DISC RESUME] (for DVD VIDEO/VIDEO CD)	[ON] [*]	Stores the resume playback point in the memory for up to 6 discs.
	[OFF]	Playback starts at the resume playback point only for the current disc in the system.
[RESET]	Returns the setup menu settings to the default settings. For details, see Returning the setup menu settings to the default .	

* Default setting

Setting the HDMI options – [HDMI SETUP]

[HDMI RESOLUTION]	[AUTO(1920x1080p)] ^{*1}	Outputs video signals according to the resolution of the TV.
	[1920x1080i]/[1280x720p]/[720x480p] ^{*2} /[720x480/576p] ^{*3}	Outputs video signals according to the selected resolution setting.
[YCBCR/RGB(HDMI)]	[YCBCR] ^{*1}	Outputs YCBCR video signals.
	[RGB]	Outputs RGB video signals.
[AUDIO(HDMI)]	[AUTO] ^{*1}	Outputs audio signals in original format from the HDMI OUT (TV) ARC connector on the system.
	[PCM]	Outputs 2-channel Linear PCM signals from the HDMI OUT (TV) ARC connector on the system.
[CONTROL FOR HDMI]	[ON] ^{*1}	The Control for HDMI function is enabled. You can operate mutually between system and TV connected with an HDMI cable.
	[OFF]	Off.
[AUDIO RETURN CHANNEL] (Available when you set [CONTROL FOR HDMI] to [ON])	[ON] ^{*1}	You can listen to TV sound from the speakers of the system. Set this function when the system is connected to a TV's HDMI IN connector that is compatible with the Audio Return Channel (ARC) function.
	[OFF]	Off.

<p>[STANDBY LINKED TO TV] (Available when you set [CONTROL FOR HDMI] to [ON])</p>	[AUTO] ^{*1}	<p>When you turn off the TV, the system turns off automatically in the following conditions:</p> <ul style="list-style-type: none"> ● While playing video in the DVD/CD or USB function. ● When the audio playback is stopped in the DVD/CD or USB function. ● When the TV function is selected.
	[ON]	<p>The system turns off automatically when you turn off the TV regardless of the function.</p>
	[OFF]	<p>The system does not turn off when you turn off the TV.</p>

*1 Default setting

*2 For Latin American models only.

*3 For other models.

Home Audio System
MHC-V73D

About the indicators

BLUETOOTH indicator

Lights up	BLUETOOTH connection is established.
Flashes twice repeatedly	The system enters the pairing mode.
Flashes slowly	The system is waiting for a BLUETOOTH device to connect to.

MEGA BASS indicator

Lights up	The MEGA BASS mode is turned on.
Turns off	The MEGA BASS mode is turned off.

Related Topic

- [Main unit](#)
- [Enjoying wireless playback using multiple audio systems \(Wireless Party Chain function\)](#)

Home Audio System
MHC-V73D

Updating the pre-installed software

The software of this system may be updated in the future. You can update your system's preinstalled software from the support website. Follow the online instructions to update the software.

5-014-121-11(2) Copyright 2020 Sony Corporation

Parental Control area code list

Code	Area	Code	Area	Code	Area	Code	Area
2044	Argentina	2115	Denmark	2304	Korea	2436	Portugal
2047	Australia	2165	Finland	2363	Malaysia	2489	Russia
2046	Austria	2174	France	2362	Mexico	2501	Singapore
2057	Belgium	2109	Germany	2376	Netherlands	2149	Spain
2070	Brazil	2248	India	2390	New Zealand	2499	Sweden
2079	Canada	2238	Indonesia	2379	Norway	2086	Switzerland
2090	Chile	2254	Italy	2427	Pakistan	2528	Thailand
2092	China	2276	Japan	2424	Philippines	2184	United Kingdom

Language code list

The language spellings conform to the ISO 639:1988 (E/F) standard.

Code	Language	Code	Language	Code	Language	Code	Language
1027	Afar	1186	Scots Gaelic	1350	Malayalam	1513	Siswati
1028	Abkhazian	1194	Galician	1352	Mongolian	1514	Sesotho
1032	Afrikaans	1196	Guarani	1353	Moldavian	1515	Sundanese
1039	Amharic	1203	Gujarati	1356	Marathi	1516	Swedish
1044	Arabic	1209	Hausa	1357	Malay	1517	Swahili
1045	Assamese	1217	Hindi	1358	Maltese	1521	Tamil
1051	Aymara	1226	Croatian	1363	Burmese	1525	Telugu
1052	Azerbaijani	1229	Hungarian	1365	Nauru	1527	Tajik
1053	Bashkir	1233	Armenian	1369	Nepali	1528	Thai
1057	Byelorussian	1235	Interlingua	1376	Dutch	1529	Tigrinya
1059	Bulgarian	1239	Interlingue	1379	Norwegian	1531	Turkmen
1060	Bihari	1245	Inupiak	1393	Occitan	1532	Tagalog
1061	Bislama	1248	Indonesian	1403	(Afan) Oromo	1534	Setswana
1066	Bengali; Bangla	1253	Icelandic	1408	Oriya	1535	Tonga
1067	Tibetan	1254	Italian	1417	Punjabi	1538	Turkish
1070	Breton	1257	Hebrew	1428	Polish	1539	Tsonga
1079	Catalan	1261	Japanese	1435	Pashto; Pushto	1540	Tatar
1093	Corsican	1269	Yiddish	1436	Portuguese	1543	Twi
1097	Czech	1283	Javanese	1463	Quechua	1557	Ukrainian
1103	Welsh	1287	Georgian	1481	Rhaeto-Romance	1564	Urdu
1105	Danish	1297	Kazakh	1482	Kirundi	1572	Uzbek
1109	German	1298	Greenlandic	1483	Romanian	1581	Vietnamese
1130	Bhutani	1299	Cambodian	1489	Russian	1587	Volapük
1142	Greek	1300	Kannada	1491	Kinyarwanda	1613	Wolof
1144	English	1301	Korean	1495	Sanskrit	1632	Xhosa

Code	Language	Code	Language	Code	Language	Code	Language
1145	Esperanto	1305	Kashmiri	1498	Sindhi	1665	Yoruba
1149	Spanish	1307	Kurdish	1501	Sangho	1684	Chinese
1150	Estonian	1311	Kirghiz	1502	Serbo-Croatian	1697	Zulu
1151	Basque	1313	Latin	1503	Singhalese	1703	Not specified
1157	Persian	1326	Lingala	1505	Slovak		
1165	Finnish	1327	Laothian	1506	Slovenian		
1166	Fiji	1332	Lithuanian	1507	Samoan		
1171	Faroese	1334	Latvian; Lettish	1508	Shona		
1174	French	1345	Malagasy	1509	Somali		
1181	Frisian	1347	Maori	1511	Albanian		
1183	Irish	1349	Macedonian	1512	Serbian		

5-014-121-11(2) Copyright 2020 Sony Corporation

What can I do to solve a problem?

If the system does not function as expected, try the following steps to resolve the issue.

- Find the symptoms of the issue in this Help Guide and try any corrective actions listed.
- Reset the system. (See [The system does not operate properly.](#))
- Look up information on the issue on the customer support website.
- Access the support websites to get support information about your system.
 - For customers in Americas:
<https://www.sony.com/am/support>
 - For customers in Europe:
<https://www.sony.eu/support>
 - For customers in other countries/regions:
<https://www.sony-asia.com/support>

Note

- If the service personnel changes some parts during repair, these parts may be retained.

Related Topic

- [The system does not operate properly.](#)

Home Audio System
MHC-V73D

About Self-diagnosis function

When the self-diagnosis function is activated, a service number appears on the TV screen or the display. The service number consists of an alphabet and numerals (e.g. C 13 50). See the following table for the cause and corrective action.

First 3 characters of the service number	Cause and corrective action
C 13	This disc is dirty. Clean the disc with a soft cloth.
C 31	The disc is not inserted correctly. Turn off the system, then turn it back on again. Then re-insert the disc correctly.
E XX (XX is a number)	To prevent a malfunction, the system has performed the self-diagnosis function. Contact your nearest Sony dealer or local authorized Sony service facility and give the 5-character service number. Example: E 61 10

Related Topic

- [Hooking up TV](#)

About messages

One of the following messages may appear or flash on the display during operation.

Message	Cause
CANNOT PLAY	<ul style="list-style-type: none"> ● A disc that cannot be played back was inserted. ● A DVD VIDEO with unsupported region code was loaded.
CODE 01/SGNL ERR	An unsupported audio signal is input from the connected TV's HDMI IN (ARC) connector. (See No TV sound is heard from the system. [CODE 01] and [SGNL ERR] appear on the display.)
DATA ERROR	<ul style="list-style-type: none"> ● The file is created in unsupported format. ● The file extension does not match the file format.
DEVICE ERROR	The USB device could not be recognized or an unknown device is connected.
DEVICE FULL	The memory of the USB device is full.
ERASE ERROR	Erase of audio files or folders on the USB device failed.
FATAL ERROR	The USB device was removed during transfer or erase operation, and may have been damaged.
FOLDER FULL	You cannot transfer onto the USB device because the number of folders has reached its maximum.
NoDEVICE	No USB device is connected or unsupported device is connected.
NO DISC	There is no disc in the system.
NO MUSIC	No supported audio files exist in the playback source.
NO SUPPORT	An unsupported USB device is connected, or the USB device is connected through a USB hub.
NO VIDEO	No supported video files exist in the playback source.
NOT USE	You tried to perform a specific operation under conditions where that operation is prohibited.
OVER CURRENT	An over current from the ψ (USB) port was detected.
PROTECT	The USB device is write-protected.
PUSH STOP	You tried to perform an operation that can be performed only when the playback is stopped.
READING	The system is reading information of the disc or USB device. Some operations are not available.
REC ERROR	The transfer did not start, stopped partway, or otherwise could not be performed.
TRACK FULL	You cannot transfer onto the USB device because the number of files has reached its maximum.

Home Audio System
MHC-V73D

The power does not turn on.

- Check that the AC power cord (mains lead) is connected securely to the AC IN jack on the rear of the system.
-

Related Topic

- [Connecting the system to an AC outlet](#)
- [Turning the power on](#)

Home Audio System
MHC-V73D

The system has entered standby mode.

- This is not a malfunction. The system enters standby mode automatically in about 15 minutes when there is no operation or audio signal output.
-
-

Related Topic

- [Auto Standby function](#)

Home Audio System
MHC-V73D

There is no sound.

- Adjust the volume.
 - Check the connection of the optional equipment, if any.
 - Turn on the connected equipment.
 - Turn off the system, unplug the AC power cord (mains lead), then plug in the AC power cord (mains lead) again and turn on the system.
-

Related Topic

- [Connecting the system to an AC outlet](#)
- [Turning the power on](#)

Home Audio System
MHC-V73D

There is severe hum or noise.

- Move the system away from sources of noise.
- Connect the system to a different wall outlet.
- Install a noise filter (not supplied) to the AC power cord (mains lead).
- Turn off surrounding electrical equipment.
- The noise generated by the cooling fans of the system may be heard when the system is turned on. This is not a malfunction.
- Move the system away from the neon signs or fluorescent light.

Home Audio System
MHC-V73D

The remote control does not function.

- Check the polarity of the batteries.
 - Remove the obstacles between the remote control and the system.
 - Move the remote control closer to the system.
 - Point the remote control at the system's sensor.
 - Replace the batteries R03 or LR03 (size AAA).
 - Move the system away from the fluorescent light.
-

Related Topic

- [Inserting batteries to the remote control](#)

Home Audio System
MHC-V73D

The color irregularity on a TV screen persists.

- Turn off the TV, then turn it on after 15 to 30 minutes. If the color irregularity still persists, place the system farther away from the TV.

Home Audio System
MHC-V73D

[CHILD LOCK] appears when you use any control on the system.

- Set the Child Lock function to off.
-

Related Topic

- [Deactivating the controls on the system \(Child Lock\)](#)

Home Audio System
MHC-V73D

A clicking sound is heard when the system is turned on.

- This is the operating sound and it occurs when the system is turned on or off, for example. This is not a malfunction.

The system does not turn on even when the TV is turned on.

-
- Hold down SHIFT and press SETUP, then set [HDMI SETUP] – [CONTROL FOR HDMI] to [ON]. The TV must support the Control for HDMI function. For details, refer to the operating instructions of your TV.
 - Check the speaker settings of the TV. The system power syncs with the speaker settings of the TV. For details, refer to the operating instructions of your TV.
 - If the sound was output from the TV's speakers the previous time, the system does not turn on even when the TV is turned on.

Home Audio System
MHC-V73D

The system turns off when the TV is turned off.

- The [STANDBY LINKED TO TV] in [HDMI SETUP] is set to [ON], the system turns off automatically when you turn off the TV regardless of the input.

Home Audio System
MHC-V73D

The system does not turn off even when the TV is turned off.

- To turn the system off automatically regardless of the input when you turn off the TV, set [STANDBY LINKED TO TV] to [ON]. The TV must support the Control for HDMI function. For details, refer to the operating instructions of your TV.

Home Audio System
MHC-V73D

There is no picture/sound when connected to the HDMI OUT (TV) ARC connector.

- Change the setting in [HDMI SETUP] – [HDMI RESOLUTION]. The problem may be solved.
- The equipment connected to the HDMI OUT (TV) ARC connector does not conform to the audio signal format. In this case, set [HDMI SETUP] – [AUDIO(HDMI)] to [PCM].
- Try the following:
 - Turn the system off and on again.
 - Turn the connected equipment off and on again.
 - Disconnect then connect the HDMI cable again.

No TV sound is output from the system.

- Check the type and connection of the HDMI cable or audio cable that is connected to the system and the TV.
 - If your TV is compatible with Audio Return Channel, make sure the system is connected to an ARC-compatible HDMI IN connector of the TV. If sound is still not output or if sound is interrupted, connect an audio cable (not supplied), hold down SHIFT and press SETUP, then set [HDMI SETUP] – [AUDIO RETURN CHANNEL] to [OFF].
 - If your TV is not compatible with Audio Return Channel, TV sound will not be output from the system even if the system is connected to the TV's HDMI IN connector. To output TV sound from the system, connect an audio cable (not supplied).
 - Change the function of the system to [TV].
 - Increase the volume on the system.
 - Depending on the order in which you turn on the TV or system first, the system may be muted and [] (muting) lights up on the display of the system. If this happens, turn on the TV first, then the system.
 - Set the speakers setting of the TV (BRAVIA) to Audio System. Refer to the operating instructions of your TV on how to set the TV.
-

Related Topic

- [Hooking up TV](#)

Home Audio System
MHC-V73D

No TV sound is heard from the system. [CODE 01] and [SGNL ERR] appear on the display.

-
- This system supports 2-channel Linear PCM formats only. Check the audio output setting on the TV and change it to PCM output mode if automatic mode is selected. For details, refer to the operating instructions of your TV.
 - Check that the speaker output setting on the TV is set to use external speakers.

Home Audio System
MHC-V73D

The sound is output from both the system and the TV.

- Mute the sound of the system or the TV.
- Change the speaker output on the TV to TV speaker or Audio System.

The Control for HDMI function does not work properly.

- Check the connection with the system.
 - Enable the Control for HDMI function on the TV. For details, refer to the operating instructions of your TV.
 - Wait a while, then try again. If you unplug the system, it will take a while before operations can be made. Wait for 15 seconds or longer, then try again.
 - Make sure the TV connected to the system supports the Control for HDMI function.
 - The type and number of devices that can be controlled by the Control for HDMI function is restricted by the HDMI CEC standard as follows:
 - Recording devices (Blu-ray Disc recorder, DVD recorder, etc.): up to 3 devices
 - Playback devices (Blu-ray Disc player, DVD player, etc.): up to 3 devices (this system uses one of them)
 - Tuner-related devices: up to 4 devices
 - Audio system (receiver/headphone): up to 1 device (used by this system)
-

Related Topic

- [Hooking up TV](#)

Home Audio System
MHC-V73D

The disc tray does not open and [LOCKED] appears on the display.

- Consult your nearest Sony dealer or local authorized Sony service facility.

Home Audio System
MHC-V73D

The disc tray does not close.

- Load the disc correctly.

Home Audio System
MHC-V73D

The disc does not eject.

- You cannot eject the disc during Synchronized Transfer or REC1 Transfer. Press ■ (stop) to cancel the transfer, then touch ▲ (open/close) on the system to eject the disc.
- Consult your nearest Sony dealer.

5-014-121-11(2) Copyright 2020 Sony Corporation

Home Audio System
MHC-V73D

Playback does not start.

- Load a disc with the label facing up.
 - Wipe the disc clean.
 - Reload the disc.
 - Load the disc that this system can play back.
 - Remove the disc and wipe away the moisture on the disc, then leave the system turned on for a few hours until the moisture evaporates.
 - The DVD VIDEO with unsupported region code was loaded.
-

Related Topic

- [Turning the power on](#)
- [Turning the power off \(Standby mode\)](#)
- [Connecting with a USB device](#)
- [Playable discs or files on discs/USB device](#)

Home Audio System
MHC-V73D

The sound skips during disc playback.

- Wipe the disc clean.
- Reload the disc.
- Move the system to a place with no vibration.
- Replace the disc with the one without defects.

Home Audio System
MHC-V73D

Playback does not start from the first track/file.

- Set the play mode to Normal Play.
- Resume Play has been selected on the disc. Press ■ (stop) twice. Then, press ► (play) to start playback.

5-014-121-11(2) Copyright 2020 Sony Corporation

Home Audio System
MHC-V73D

You cannot perform some functions such as Stop, Lock Search, Slow-motion Play, Repeat Play, or Shuffle Play.

-
- Depending on the disc, you may not be able to do some of the operations above. Refer to the operating instructions supplied with the disc.

Home Audio System
MHC-V73D

Files cannot be played back.

- The data is not stored in the supported format.
- Make sure you have selected the correct MEDIA MODE setting before playback.

5-014-121-11(2) Copyright 2020 Sony Corporation

Home Audio System
MHC-V73D

The name does not appear properly.

- The ID3 version is not in Version 1 (1.0/1.1) or Version 2 (2.2/2.3).
- The character codes that can be displayed by this system are as follows:
 - Upper cases (A to Z)
 - Numbers (0 to 9)
 - Symbols (< > * + , [] \ _)

Other characters appear as [].

Home Audio System
MHC-V73D

[READING] is displayed for an extended time, or it takes a long time before playback starts.

-
- The reading process can take a long time when the file structure is extremely complex.

Home Audio System
MHC-V73D

There is no picture.

- Check that the system is connected securely.
 - If the HDMI cable is damaged, replace it with a new one.
 - Make sure you connect the system to the HDMI IN connector of your TV.
 - Make sure you turn on the TV and operate the TV correctly.
 - Make sure you select the input according to the connection on the TV so that you can view the pictures from the system.
 - (Except for Latin American, Brazilian, European, and Russian models)
Make sure you set the color system correctly, according to your TV's color system.
-
-

Related Topic

- [Hooking up TV](#)
- [Using the Control for HDMI function](#)

Home Audio System
MHC-V73D

Picture noise appears.

- Wipe the disc clean.
 - (Except for Latin American, Brazilian, European, and Russian models)
Set the color system to match your TV.
-
-

Related Topic

- [Hooking up TV](#)

Home Audio System
MHC-V73D

The aspect ratio of the TV screen cannot be changed.

- The aspect ratio is fixed on your DVD VIDEO and video file.
- Depending on the TV, you may not be able to change the aspect ratio.

Home Audio System
MHC-V73D

The language for sound track, subtitles, or camera angles cannot be changed.

- Multilingual tracks, multilingual subtitles, or multi-angles are not recorded on the DVD VIDEO being played back.
- The DVD VIDEO prohibits changing the setting.

5-014-121-11(2) Copyright 2020 Sony Corporation

Home Audio System
MHC-V73D

The subtitles cannot be turned off.

- The DVD VIDEO prohibits turning off subtitles.

Home Audio System
MHC-V73D

Playback does not start.

- Turn off the system and reconnect the USB device, then turn on the system.
- Resume Play has been selected on the USB device. Press ■ (stop) twice. Then, press ► (play) to start playback.

5-014-121-11(2) Copyright 2020 Sony Corporation

Home Audio System
MHC-V73D

Playback does not start from the first file.

- Set the play mode to Normal Play.

Files cannot be played back.

- The data is not stored in the supported format.
- Make sure you have selected the correct MEDIA MODE setting before playback.
- USB devices formatted with file systems other than FAT16 or FAT32 are unsupported.
This system supports FAT16 and FAT32, but some USB devices may not support all of these FAT. For details, refer to the operating instructions of each USB device or contact the manufacturer.
- If you use a partitioned USB device, only files on the first partition can be played back.

Home Audio System
MHC-V73D

The name does not appear properly.

- The ID3 version is not in Version 1 (1.0/1.1) or Version 2 (2.2/2.3).
- The data stored in the USB device may have been corrupted, perform the transfer again.
- The character codes that can be displayed by this system are as follows:
 - Upper cases (A to Z)
 - Numbers (0 to 9)
 - Symbols (< > * + , [] \ _)

Other characters appear as [].

Home Audio System
MHC-V73D

There is no sound during USB playback.

- The USB device is not connected correctly. Turn off the system and reconnect the USB device, then turn on the system and check if [USB] appears on the display.
-
-

Related Topic

- [Turning the power on](#)
- [Turning the power off \(Standby mode\)](#)
- [Connecting with a USB device](#)
- [Playing a USB device](#)

Home Audio System
MHC-V73D

There is noise, skipping, or distorted sound during USB playback.

- Turn off the system and reconnect the USB device, then turn on the system.
 - The music data itself contains noise, or the sound is distorted. Noise may have entered during the transfer process. Delete the file, and try transfer again.
 - The bit rate used in encoding an audio file was low. Send an audio file with higher bit rate to the USB device.
-

Related Topic



- [Turning the power on](#)
- [Turning the power off \(Standby mode\)](#)
- [Connecting with a USB device](#)

[READING] is displayed for an extended time, or it takes a long time before playback starts.

-
- The reading process can take a long time in the following cases.
 - There are many folders or files on the USB device. For details, see “Notes on playable files” in [Playable discs or files on discs/USB device](#).
 - The file structure is extremely complex.
 - The memory capacity is excessive.
 - The internal memory is fragmented.

Home Audio System
MHC-V73D

[NO FILE] appears on the display.

- The system has entered the software update mode, and all controls (except  (power)) are deactivated. Press  (power) on the system to cancel the software update.

Home Audio System
MHC-V73D

[OVER CURRENT] appears on the display.

-
- A problem has been detected with the level of electrical current from the ψ (USB) port on the system. Turn off the system and remove the USB device from the port. Make sure there is no problem with the USB device. If this display pattern persists, contact your nearest Sony dealer.
-

Related Topic

- [Turning the power off \(Standby mode\)](#)

Home Audio System
MHC-V73D

The USB device is not recognized.

- Turn off the system and reconnect the USB device, then turn on the system.
 - The USB device is not working properly. Refer to the operating instructions of the USB device on how to deal with this problem.
-

Related Topic

- [Turning the power on](#)
- [Turning the power off \(Standby mode\)](#)
- [Connecting with a USB device](#)

Transferring results in an error.



- The USB device is not formatted correctly. Refer to the operating instructions of the USB device on how to format.
- Turn off the system and remove the USB device. If the USB device has a power switch, turn the USB device off and on again after removing it from the system. Then, perform the transfer again.
- If the transfer and erase operations are repeated multiple times, the file structure within the USB device becomes fragmented. Refer to the operating instructions of the USB device on how to deal with this problem.
- The USB device was disconnected or the power was turned off during transfer. Delete the partially-transferred file, and perform the transfer again. If this does not fix the problem, the USB device may be broken. Refer to the operating instructions of the USB device on how to deal with this problem.

Home Audio System
MHC-V73D

Audio files or folders on the USB device cannot be erased.

- Check if the USB device is write-protected.
- The USB device was disconnected or the power was turned off during the erase operation. Delete the partially-erased file. If this does not fix the problem, the USB device may be broken. Refer to the operating instructions of the USB device on how to deal with this problem.

Pairing cannot be performed.

- You cannot perform pairing simply by holding down BLUETOOTH/  PAIRING on the system. Be sure to activate the BLUETOOTH function first, and then hold down BLUETOOTH/  PAIRING to perform pairing.
 - Move the BLUETOOTH device closer to the system.
 - Pairing may not be possible if other BLUETOOTH devices are present around the system. In this case, turn off the other BLUETOOTH devices.
 - Make sure to enter the correct passkey when selecting the system's name (this system) on the BLUETOOTH device.
-

Related Topic

- [Pairing and connecting with BLUETOOTH devices](#)

Home Audio System
MHC-V73D

The BLUETOOTH device cannot detect the system, or [BT OFF] appears on the display.

-
- Set the BLUETOOTH signal to [BT ON].
-
-

Related Topic

- [Turning on or off the BLUETOOTH signal](#)

Home Audio System
MHC-V73D

Connection is not possible.

- The BLUETOOTH device you attempted to connect does not support the A2DP profile, and cannot be connected with the system.
 - Enable the BLUETOOTH function of the BLUETOOTH device.
 - Establish a connection from the BLUETOOTH device.
 - The pairing registration information has been erased.
Perform the pairing operation again.
-

Related Topic

- [Pairing and connecting with BLUETOOTH devices](#)

Home Audio System
MHC-V73D

iPhone/iPod cannot be connected with the system.

- The system is compatible with iOS 11.0 or later.

The sound skips or fluctuates, or the connection is lost.

- The system and the BLUETOOTH device are too far apart.
 - If there are obstacles between the system and your BLUETOOTH device, remove or avoid the obstacles.
 - If there is equipment that generates electromagnetic radiation, such as a wireless LAN, other BLUETOOTH device, or a microwave oven nearby, move them away.
 - Select the appropriate audio codec option.
-

Related Topic

- [Selecting the BLUETOOTH audio streaming playback quality \(Codec\)](#)

Home Audio System
MHC-V73D

The sound of your BLUETOOTH device cannot be heard on this system.

- Increase the volume on your BLUETOOTH device first, then adjust the volume using  (volume) +/- (VOLUME +/- on the system).

Home Audio System
MHC-V73D

There is severe hum, noise, or distorted sound.

- If there are obstacles between the system and your BLUETOOTH device, remove or avoid the obstacles.
- If there is equipment that generates electromagnetic radiation, such as a wireless LAN, other BLUETOOTH device, or a microwave oven nearby, move them away.
- Turn down the volume of the connected BLUETOOTH device.

There is severe hum or noise, or stations cannot be received.

- Connect the FM lead antenna (aerial) properly.
- Change antenna location and its orientation to obtain good reception.
- Turn off nearby electrical equipment.
- Radio may not be received depending on the radio wave conditions or the housing environment in your area.

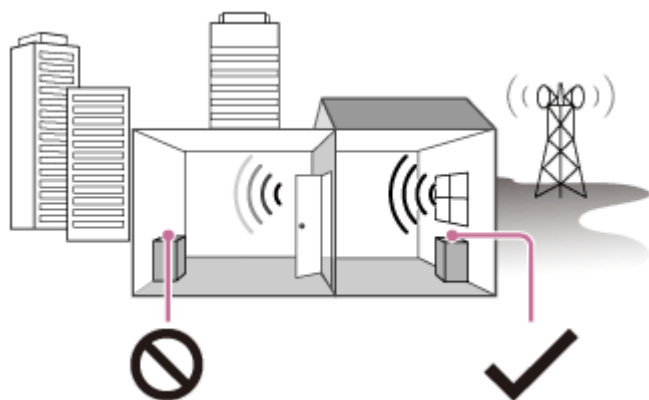

Poor reception: Far from windows, between buildings, etc.



Good reception: Near windows, etc.

Home Audio System
MHC-V73D

The stereo FM reception is noisy.

- To reduce static noise on a weak FM stereo station, press REPEAT/FM MODE repeatedly until [ST] lights off on the display.
You will lose the stereo effect, but reception will improve.
-
-

Related Topic

- [Listening to FM radio](#)

Home Audio System
MHC-V73D

The BLUETOOTH device cannot be connected to the system during Wireless Party Chain function.

-
- After connecting all the systems, perform the pairing and connecting operations between the BLUETOOTH device and the Party Host.
-

Related Topic

- [Enjoying wireless playback using multiple audio systems \(Wireless Party Chain function\)](#)
- [Terminating the Wireless Party Chain function](#)

Home Audio System
MHC-V73D

The BLUETOOTH device cannot be connected to the system during Stereo Pair function.

-
- After connecting two same model systems, perform the pairing and connecting operations between the BLUETOOTH device and the Host system.
-

Related Topic

- [Listening to music wirelessly with two systems \(Stereo Pair function\)](#)

Home Audio System
MHC-V73D

Voice Control does not work properly.

- Speak closer to your smartphone/iPhone microphone.
- Speak clearly at a slower speed.
- Reduce the surrounding noise.

5-014-121-11(2) Copyright 2020 Sony Corporation

Home Audio System
MHC-V73D

The Gesture Control cannot be activated.

- Touch GESTURE ON/OFF on the system repeatedly until the GESTURE CONTROL lights up.
 - Make sure the Child Lock function is not activated.
-

Related Topic

- [Deactivating the controls on the system \(Child Lock\)](#)

Home Audio System
MHC-V73D

The Gesture Control does not operate properly.

- Move your hand closer to the GESTURE CONTROL sensor when you perform the swiping motion.
- Perform the swiping motion at a slower speed.
- Select the correct mode (PLAYBACK, DJ, SAMPLER or KARAOKE) before you start using the Gesture Control.
- Install a noise filter (not supplied) to the AC power cord (mains lead).
- Turn off surrounding electrical equipment.

Home Audio System
MHC-V73D

There is no microphone sound.

- Adjust the microphone volume level.
- Make sure the microphone is connected to the MIC1 or MIC2/GUITAR jack on the system correctly.
- Make sure the microphone is turned on.

5-014-121-11(2) Copyright 2020 Sony Corporation

Home Audio System
MHC-V73D

There is acoustic feedback.

- Reduce the volume.
- Move the microphone and guitar away from the system or change the direction of the microphone.

5-014-121-11(2) Copyright 2020 Sony Corporation

Home Audio System
MHC-V73D

The sound loses stereo effect during playback.

- Turn off the Vocal Fader.
 - Make sure the system is connected properly.
-
-

Related Topic

- [Various functions for karaoke](#)

Home Audio System
MHC-V73D

The system does not operate properly.

Reset the system to factory default settings.
Use the controls on the system to perform this operation.

1 Unplug the AC power cord (mains lead) from the system, then plug it back in.

2 Press  (power) to turn on the system.

3 Hold down GUITAR and MEGA BASS for about 3 seconds.

After all the indicators on the system flash for more than 3 seconds, all user-configured settings, such as the pairing registration information, are reset to factory default settings.

[RESET] appears on the display.

After the reset completes, the system automatically reboots. Press  (power) to turn on the system.











All user-configured settings, such as the pairing registration information, are reset to factory default settings (except for some setup menu settings). To reset all setup menu settings, see [Returning the setup menu settings to the default](#).

Related Topic

- [Hooking up TV](#)

Returning the setup menu settings to the default

You can return the setup menu settings (except for [PARENTAL CONTROL] settings) to the default settings.

- 1 Hold down SHIFT and press SETUP.**
The setup menu appears on the TV screen.
- 2 Press  (up)/  (down) repeatedly to select [SYSTEM SETUP], then press  (enter).**
- 3 Press  (up)/  (down) repeatedly to select [RESET], then press  (enter).**
- 4 Press  (up)/  (down) repeatedly to select [YES], then press  (enter).**
It takes a few seconds to complete. Do not press  (power) while resetting the system.

Related Topic

- [Hooking up TV](#)