

# Ion PGM™ Template OT2 200 Kit

## USER GUIDE

for use with the Ion OneTouch™ 2 System

Catalog Number 4480974

Publication Number MAN0007220

Revision B.0

The information in this guide is subject to change without notice.

**DISCLAIMER**

TO THE EXTENT ALLOWED BY LAW, LIFE TECHNOLOGIES AND/OR ITS AFFILIATE(S) WILL NOT BE LIABLE FOR SPECIAL, INCIDENTAL, INDIRECT, PUNITIVE, MULTIPLE, OR CONSEQUENTIAL DAMAGES IN CONNECTION WITH OR ARISING FROM THIS DOCUMENT, INCLUDING YOUR USE OF IT.

**Important Licensing Information**

This product may be covered by one or more Limited Use Label Licenses. By use of this product, you accept the terms and conditions of all applicable Limited Use Label Licenses.

**Corporate entity**

Life Technologies | Carlsbad, CA 92008 USA | Toll Free in USA 1.800.955.6288

**Trademarks**

All trademarks are the property of Thermo Fisher Scientific and its subsidiaries unless otherwise specified. Bioanalyzer is a trademark of Agilent Technologies, Inc. Agencourt and AMPure are trademarks of Beckman Coulter, Inc. Cy is a trademark of GE Healthcare UK Limited. Guava and easyCyte is a trademark of Guava Technologies, Inc. Kimwipes is a trademark of Kimberly-Clark Corporation. Eppendorf and Eppendorf LoBind are trademarks of Eppendorf AG. Luer-Lok is a trademark of Becton, Dickinson and Company. Xiameter is a trademark of Dow Corning Corporation. Microsoft, Windows, and Excel are trademarks of Microsoft Corporation. Macintosh and Mac OS are trademarks of Apple, Inc. Tween is a trademark of Uniqema Americas LLC.

©2015 Thermo Fisher Scientific Inc. All rights reserved.

# Contents

About this guide .....	7
Purpose .....	7
Revision history .....	8
■ <b>CHAPTER 1</b> Product information .....	9
Product description .....	9
Software compatibility .....	9
Kit contents and storage .....	10
Required materials and equipment (not provided) .....	12
Additional materials required for Ion OneTouch™ ES .....	13
Recommended materials for the Ion OneTouch™ 2 System .....	13
Prerequisites .....	14
Contamination .....	14
Instrument clearances .....	14
■ <b>CHAPTER 2</b> Getting started .....	15
Procedural guidelines .....	15
Unpack and install the Ion OneTouch™ 2 Instrument and Ion OneTouch™ ES .....	15
Check the firmware .....	16
Initialize the Ion OneTouch™ 2 Instrument .....	16
Perform a verification run .....	16
■ <b>CHAPTER 3</b> Prepare template-positive Ion PGM™ Template OT2 200 ISPs .....	18
Set up the Ion OneTouch™ 2 Instrument .....	18
Ion OneTouch™ 2 Instrument layout .....	19
Materials required for this procedure .....	19
Install the Ion OneTouch™ Recovery Tubes and Ion OneTouch™ Recovery Router ....	20
Install the Ion OneTouch™ 2 Amplification Plate .....	21
Install the disposable injector .....	23
Install the Ion OneTouch™ Oil .....	24

Install the Ion PGM™ OT2 Recovery Solution .....	25
Empty the Waste Container .....	25
Prepare and install the amplification solution .....	26
Prepare the amplification solution .....	26
Fill the Ion PGM™ OneTouch Plus Reaction Filter Assembly .....	29
Install the filled Ion PGM™ OneTouch Plus Reaction Filter Assembly .....	31
Run the Ion OneTouch™ 2 Instrument .....	32
Recover the template-positive Ion PGM™ Template OT2 200 ISPs .....	35
Materials required for this procedure .....	35
Recover the template-positive ISPs .....	35
Maintain the Ion OneTouch™ 2 Instrument .....	38
Materials required for this procedure .....	38
Clean the Ion OneTouch™ 2 Instrument .....	38
<b>■ CHAPTER 4 Enrich the template-positive Ion PGM™ Template OT2 200 ISPs .....</b>	<b>41</b>
Materials required .....	41
Perform the residual volume test on the Ion OneTouch™ ES .....	42
Prepare reagents then fill the 8-well strip .....	42
Prepare Melt-Off Solution .....	42
Wash and resuspend the Dynabeads™ MyOne™ Streptavidin C1 Beads .....	42
Fill the 8-well strip .....	43
Prepare the Ion OneTouch™ ES .....	45
Perform the run .....	47
Perform Ion Sphere™ Particles quality control .....	49
<b>■ APPENDIX A Troubleshooting .....</b>	<b>50</b>
Ion OneTouch™ 2 Instrument .....	50
Ion OneTouch™ ES .....	52
<b>■ APPENDIX B Quality control of Ion PGM™ Template OT2 200 ISPs .....</b>	<b>56</b>
Quality Control assay .....	56
Quality control using the Qubit™ 2.0 Fluorometer .....	57
Materials required .....	57
Upgrade the Qubit™ 2.0 Fluorometer firmware and software .....	58
Upgrade for firmware V2.00 or V3.00 .....	58
Upgrade for firmware V3.10 .....	61

Calculate the Qubit™ 2.0 Fluorometer Calibration Factor .....	63
Measure the templated unenriched sample .....	65
Quality control using the Qubit™ 3.0 Fluorometer .....	70
Materials required .....	70
Calculate the Qubit™ 3.0 Fluorometer Calibration Factor .....	70
Measure the templated unenriched sample .....	73
Acceptance criteria for unenriched Ion PGM™ Template OT2 200 Ion Sphere™ Particles .....	76
ISP Quality Control assay troubleshooting table .....	77
Quality control using the Guava™ easyCyte™ 5 Flow Cytometer .....	77
Quality control using the Attune™ Acoustic Focusing Cytometer .....	78
<b>■ APPENDIX C Set up, calibrate, and maintain the Ion OneTouch™ ES .....</b>	<b>79</b>
Set up the Ion OneTouch™ ES .....	79
Materials required for this procedure .....	79
Set up the instrument .....	80
Perform a residual volume test .....	83
Calibrate the Ion OneTouch™ ES Instrument .....	87
Vertical axis calibration .....	87
Horizontal axis calibration .....	89
Maintain the Ion OneTouch™ ES .....	90
Materials and equipment required .....	90
Ion OneTouch™ ES back panel layout .....	90
Lubricate the syringe annually .....	91
Decontaminate the Ion OneTouch™ ES .....	95
Materials and equipment required .....	95
Decontaminate the instrument .....	95
<b>■ APPENDIX D Supplemental procedures .....</b>	<b>96</b>
Unpack and install the Ion OneTouch™ 2 System .....	96
Unpack and install the Ion OneTouch™ 2 Instrument .....	96
Unpack and install the Ion OneTouch™ ES .....	97
Install a firmware update .....	98
Install a firmware update with a USB flash drive .....	98
Alternative method: Install a firmware update using an Ethernet connection .....	100
Initialize the Ion OneTouch™ 2 Instrument .....	101
Set up the Ion OneTouch™ 2 Instrument .....	101
Download the log files from the Ion OneTouch™ 2 Instrument .....	109
Ion OneTouch™ 2 Instrument touchscreen messages .....	110
Decontaminate the Ion OneTouch™ 2 Instrument .....	111
Materials and equipment required .....	111
Decontaminate the instrument .....	111

- **APPENDIX E Safety** ..... 112
  - Symbols on this instrument ..... 112
  - Instrument safety ..... 113
    - General ..... 113
    - Physical injury ..... 113
    - Electrical ..... 114
    - Cleaning and decontamination ..... 114
  - Safety and electromagnetic compatibility (EMC) standards ..... 115
    - Safety ..... 115
    - EMC ..... 115
    - Environmental design ..... 115
  - Chemical safety ..... 116
  - Biological hazard safety ..... 117
  
  - Documentation and support** ..... 118
    - Customer and technical support ..... 118
    - Limited product warranty ..... 118

# About this guide



**CAUTION!** ABBREVIATED SAFETY ALERTS. Hazard symbols and hazard types specified in procedures may be abbreviated in this document. For the complete safety information, see the “Safety” appendix in this document.

---

**IMPORTANT!** Before using this product, read and understand the information in the “Safety” Appendix in this document.

---

## Purpose

This user guide describes how to use the Ion OneTouch™ 2 System to prepare enriched, template-positive Ion PGM™ Template OT2 200 Ion Sphere™ Particles (ISPs) with 200 base-pair average insert libraries on the Ion PGM™ System. The Ion OneTouch™ 2 System includes the Ion OneTouch™ 2 Instrument and the Ion OneTouch™ ES Instrument.

The user guide is organized as follows:

- Prepare template-positive ISPs containing clonally amplified DNA, using the Ion PGM™ Template OT2 200 Kit (for up to 200 base-read libraries) with the Ion OneTouch™ 2 Instrument (see Chapter 3, “Prepare template-positive Ion PGM™ Template OT2 200 ISPs”).
- Enrich the template-positive ISPs with the Ion OneTouch™ ES (see Chapter 4, “Enrich the template-positive Ion PGM™ Template OT2 200 ISPs”).

---

**IMPORTANT!** Use *only* the Ion PGM™ Template OT2 200 Kit (Cat. no. 4480974) with this user guide and with the Ion OneTouch™ 2 System. Do not use the kit with the Ion OneTouch™ System. Do not mix reactions or disposables including plates, solutions, and kit reagents from other template preparation kits. Template-positive Ion PGM™ Template OT2 200 Ion Sphere™ Particles prepared with this kit should only be used in conjunction with the Ion PGM™ Sequencing 200 Kit v2 (Cat. no. 4482006). Refer to the *Ion PGM™ Sequencing 200 Kit v2 User Guide* (Pub. no. MAN0007273).

---

## Revision history

Revision	Date	Description of change
B.0	19 November 2015	<ul style="list-style-type: none"> <li>• Users recommended to upgrade firmware after updating to Torrent Suite™ Software (TSS) v5.0.</li> <li>• Users recommended to switch to the Ion PGM™ Hi-Q™ OT2 Kit when using the Ion PGM™ Hi-Q™ Sequencing Kit, because the OT2 program script enabling use of the Ion PGM™ Template OT2 200 Kit with the Ion PGM™ Hi-Q™ Sequencing Kit is discontinued in TSS v5.0. Users should upgrade to TSS v5.0 only after mixed workflow is no longer required.</li> <li>• Graphics enhanced.</li> <li>• Support added for the Qubit™ 3.0 Fluorometer.</li> </ul>
A.0	18 August 2014	<ul style="list-style-type: none"> <li>• Users recommended to upgrade firmware after updating to Torrent Server Software v4.2.</li> <li>• Support added for Ion PGM™ Hi-Q™ Sequencing Kit users.</li> <li>• Library dilution table in "Prepare and install the amplification solution" updated to 100 pM for all listed libraries.</li> <li>• Version numbering changed to alphanumeric format and reset to A.0 in conformance with internal document control procedures.</li> </ul>
5.0	14 October 2013	<ul style="list-style-type: none"> <li>• Users recommended to upgrade firmware after updating to Torrent Server Software v4.0.</li> <li>• Library dilution table added to "Prepare and install the amplification solution" on page 29.</li> <li>• Discontinuation of use of the Ion OneTouch™ Lid.</li> </ul>
4.0	21 May 2013	<ul style="list-style-type: none"> <li>• Upgrade firmware after updating to Torrent Server Software v3.6.</li> <li>• Minor reorganization of topics for greater ease of use.</li> <li>• Minor changes and corrections to text and figures made.</li> </ul>
3.0	13 March 2013	Updated screen captures and procedures associated with v3.4.2 firmware upgrade, including Final Spin functionality.
2.0	14 December 2012	<ul style="list-style-type: none"> <li>• Improved protocols.</li> <li>• Upgrade to Torrent Server Software v3.4.1.</li> </ul>
1.0	9 November 2012	<ul style="list-style-type: none"> <li>• New Ion OneTouch™ 2 Instrument</li> <li>• Simpler installation instructions.</li> <li>• New Ion PGM™ Template OT2 200 Kit.</li> </ul>





# Product information

## Product description

The Ion PGM™ Template OT2 200 Kit includes reagents required for preparing 10 reactions of template-positive Ion PGM™ Template OT2 200 Ion Sphere™ Particles (ISPs) on the Ion OneTouch™ 2 System. The Ion PGM™ Template OT2 200 Kit can be used with up to 200 base-pair average insert libraries of any type prepared using any available Ion library kit.

---

**IMPORTANT!** Use *only* the Ion PGM™ Template OT2 200 Kit (Cat. no. 4480974) with this user guide and with the Ion OneTouch™ 2 System. Do not use the kit with the Ion OneTouch™ System. Do *not* mix reactions or disposables including plates, solutions, and kit reagents from other template preparation kits.

---

---

**IMPORTANT!** The shelf life of the Ion PGM™ Template OT2 200 Reagent Mix and Ion PGM™ Template OT2 200 PCR Reagent B is 6 months from the date of initial thawing or to the date on the label, whichever date is earlier.

---

## Software compatibility

The Ion PGM™ Template OT2 200 Kit is compatible with Torrent Suite™ Software v5.0 and later. Follow these guidelines, if applicable:

- If you use the Ion PGM™ Template OT2 200 Kit together with the Ion PGM™ Hi-Q™ Sequencing Kit, we recommend that you switch to the Ion PGM™ Hi-Q™ OT2 Kit (Cat. no. A27739). The OT2 program script enabling use of the Ion PGM™ Template OT2 200 Kit with the Ion PGM™ Hi-Q™ Sequencing Kit is discontinued in the instrument firmware upgrade in Torrent Suite™ Software v5.0. If you need to continue using the mixed workflow, upgrade to Torrent Suite™ Software v5.0 or later only after you no longer require the mixed workflow.
- The Ion PGM™ Template OT2 200 Kit is not compatible with Torrent Suite™ Assay Development Software v5.0. We recommend that you use the Ion PGM™ Hi-Q™ OT2 Kit if you use this software.

## Kit contents and storage

### Ion PGM™ Template OT2 200 Kit summary

Component	Part no.	Quantity per kit
Ion PGM™ Template OT2 Reactions 200 Kit	4481106	1
Ion PGM™ Template OT2 Supplies 200 Kit	4480981	1
Ion PGM™ Template OT2 Reagents 200 Kit	4481107	1
Ion PGM™ Template OT2 Solutions 200 Kit	4481105	1

### Ion PGM™ Template OT2 200 Kit reagents and materials

Components <sup>[1]</sup>	Cap color	Quantity	Volume	Storage
<b>Ion PGM™ Template OT2 Reactions 200 Kit (Part no. 4481106)</b>				
Ion PGM™ OneTouch Plus Reaction Filter Assembly	—	10 reaction filters and tubes	—	15°C to 30°C
<b>Ion PGM™ Template OT2 Supplies 200 Kit (Part no. 4480981)</b>				
Ion OneTouch™ Reagent Tubes	—	2 tubes	—	15°C to 30°C
Ion OneTouch™ Recovery Routers	—	10 routers	—	
Ion OneTouch™ Recovery Tubes	—	20 tubes	—	
Ion OneTouch™ Sipper Tubes	—	2 tubes	—	
Ion OneTouch™ 2 Amplification Plates	—	10 plates	—	
Ion OneTouch™ ES Supplies <sup>[2]</sup>	—	1 bag	—	
Ion OneTouch™ 2 Cleaning Adapters <sup>[3]</sup>	—	10 adapters	—	
<b>Ion PGM™ Template OT2 Reagents 200 Kit (Part no. 4481107)</b>				
Ion PGM™ Template OT2 200 Reagent Mix <b>IMPORTANT!</b> The Ion PGM™ Template OT2 200 Reagent Mix is shipped at –30°C to –10°C. Immediately before use, thaw tube(s) as needed. After use, store the thawed Ion PGM™ Template OT2 200 Reagent Mix at 2°C to 8°C.	Violet	5 tubes	1000 µL each	–30°C to –10°C (2°C to 8°C after thaw)
Ion PGM™ Template OT2 200 Enzyme Mix	Brown	1 tube	500 µL	–30°C to –10°C
Ion PGM™ Template OT2 200 Ion Sphere™ Particles	Black	1 tube	1000 µL	

Components <sup>[1]</sup>	Cap color	Quantity	Volume	Storage
<b>Ion PGM™ Template OT2 Solutions 200 Kit (Part no. 4481105)</b>				
Ion PGM™ Template OT2 200 PCR Reagent B  <b>IMPORTANT!</b> The Ion PGM™ Template OT2 200 PCR Reagent B is shipped at 15°C to 30°C. Store the Ion PGM™ Template OT2 200 PCR Reagent B at room temperature. Do <i>not</i> store Ion PGM™ Template OT2 200 PCR Reagent B at 2°C to 8°C.	Blue	2 tubes	1500 µL each	15°C to 30°C
Ion OneTouch™ Oil	—	1 bottle	450 mL	
Ion OneTouch™ Reaction Oil	—	1 bottle	27 mL	
Nuclease-free Water	—	1 tube	15 mL	
Ion PGM™ OT2 Recovery Solution	—	1 bottle	350 mL	
Ion OneTouch™ Wash Solution	—	1 bottle	25 mL	
MyOne™ Beads Wash Solution	Green	2 vials	1400 µL each	
Neutralization Solution	Red	1 vial	100 µL	
Tween™ Solution	—	1 bottle	6 mL	

<sup>[1]</sup> We have verified this protocol using this specific material. Substitution may adversely affect performance.

<sup>[2]</sup> Ion OneTouch™ ES Supplies include 12 Eppendorf® LoRetention Dualfilter, 300 µL, PCR pipette tips (Fisher Cat. no. 02-717-342), and loose 8-well strips. The ES supplies may be located at the bottom of the box.

<sup>[3]</sup> Each Ion OneTouch™ 2 Cleaning Adapter is used for *one* cleaning only.

## Required materials and equipment (not provided)

Unless otherwise indicated, all materials are available through **thermofisher.com**.  
MLS: Fisher Scientific ([www.fisherscientific.com](http://www.fisherscientific.com)) or other major laboratory supplier.

✓	Description <sup>[1]</sup>	Source
	Ion OneTouch™ 2 System The system includes: <ul style="list-style-type: none"> <li>• Ion OneTouch™ 2 Instrument</li> <li>• Ion OneTouch™ ES</li> <li>• AC Power Supply and Cords</li> <li>• Installation Kit</li> </ul>	4474779
	Ion PGM™ Enrichment Beads (Dynabeads™ MyOne™ Streptavidin C1 Beads)	4478525
	GeneAmp™ PCR System 9700 thermal cycler or equivalent	N8050200 (Base) 4314443 (Block)
	1.5-mL Eppendorf LoBind™ Tubes	Fisher Scientific 13-864-254
	Microcentrifuge <sup>[2]</sup>	MLS
	Pipettes (P2, P20, P200, P1000) and appropriate low-retention tips	MLS
	Vortexer with a rubber platform	MLS
	Tube rack to fit 15-mL conical tube	MLS
	Tube rack for 50-mL conical tube	MLS
	Heat block set to 75°C	MLS

<sup>[1]</sup> We have verified this protocol using this specific material. Substitution may adversely affect system performance.

<sup>[2]</sup> Must fit standard 0.2- and 1.5-mL microcentrifuge tubes; must generate 15,500 × *g*.

**Note:** We recommend using an uninterruptable power supply (UPS) for laboratories that experience frequent power outages or line voltage fluctuations. The UPS must be rated for 1500 W output or higher. The 1500 VA unit from APC provides several minutes of backup power for the Ion OneTouch™ 2 Instrument, the Ion OneTouch™ ES Instrument, the Ion PGM™ Sequencer, and the Torrent Server. Use a surge protector or line conditioner as needed (see “Unpack and install the Ion OneTouch™ 2 System” on page 96).

### Additional materials required for Ion OneTouch™ ES

The following additional materials are required for use and maintenance of the Ion OneTouch™ ES Instrument:

✓	Description <sup>[1]</sup>	Source
	DynaMag™ -2 magnet	12321D
	0.2-mL PCR tubes	Fisher Scientific 14-222-283 or MLS
	1 M NaOH	MLS
	Xiameter™ PMX-200 Silicone Fluid <sup>[2]</sup>	Neely Industries PMX200-12500PT

<sup>[1]</sup> We have verified this protocol using this specific material. Substitution may adversely affect system performance.

<sup>[2]</sup> Material required for periodic maintenance of the Ion OneTouch™ ES.

### Recommended materials for the Ion OneTouch™ 2 System

Unless otherwise indicated, all materials are available through **thermofisher.com**.  
 MLS: Fisher Scientific ([www.fisherscientific.com](http://www.fisherscientific.com)) or other major laboratory supplier.

✓	Description <sup>[1,2]</sup>	Source
	Ion PGM™ Controls Kit v2	4482010
	Benchtop absorbent paper or mat	MLS
	Bleach	MLS
	Ethernet cable	MLS
	1/8-inch L-wrench (hex wrench) or equivalent tool	MLS

<sup>[1]</sup> We have verified this protocol using this specific material. Substitution may adversely affect system performance.

<sup>[2]</sup> For materials needed for optional quality control of ISPs by the Qubit™ 2.0 or Qubit™ 3.0 Fluorometer, see Appendix B, "Quality control of Ion PGM™ Template OT2 200 ISPs".

## Prerequisites

The manufacturer is not liable for any damage or injury that results from use of this manual by unauthorized or untrained parties. This guide uses conventions and terminology that assume a working knowledge of the Microsoft™ Windows™ operating system, the Internet, and Internet-based browsers.

## Contamination



**CAUTION!** A primary source of contamination is DNA fragments from previous sample processing steps. Do not introduce amplified DNA into library preparation laboratory or work area.

---

## Instrument clearances

**Ion OneTouch™ 2 Instrument and Ion OneTouch™ ES Space Requirements and Clearances:** Position the instrument so that the front is a minimum of 12 in. (30.5 cm) from the front of the laboratory bench. Place the instrument at least 40 in. (1 meter) away from major sources of electronic noise such as refrigerators or microwaves. For more information, refer to the *Ion Personal Genome Machine™ System Site Preparation Guide for use with Ion Personal Genome Machine™ Sequencer, Ion Torrent™ Server, and Ion OneTouch™ 2 System* (Pub. no. MAN0007516).



# Getting started

■ Procedural guidelines .....	15
■ Unpack and install the Ion OneTouch™ 2 Instrument and Ion OneTouch™ ES .....	15
■ Check the firmware .....	16
■ Initialize the Ion OneTouch™ 2 Instrument .....	16
■ Perform a verification run .....	16

## Procedural guidelines

- Use good laboratory practices to minimize cross-contamination of products. When designing the laboratory layout, consider the need for space separation of pre- and post-PCR activities. Separate the amplicon source and post-PCR activities from pre-PCR activities. Dedicate laboratory supplies and/or equipment to the appropriate space to significantly reduce the potential for contamination.
- Unless otherwise specified, thaw reagents on ice before use.

## Unpack and install the Ion OneTouch™ 2 Instrument and Ion OneTouch™ ES

For detailed instructions on site preparation and installation of the Ion OneTouch™ 2 Instrument and Ion OneTouch™ ES, refer to:

- Site preparation and installation requirements: Refer to the *Ion Personal Genome Machine™ System Site Preparation Guide for use with the Ion Personal Genome Machine™ Sequencer, Ion Torrent Server, and the Ion OneTouch™ 2 System* (Pub. no. MAN0007516).
- Unpacking and installation instructions: See “Unpack and install the Ion OneTouch™ 2 System” on page 96.

## Check the firmware

Firmware updates to the software controlling the Ion OneTouch™ 2 Instrument are periodically released. To check the firmware version, on the instrument touch screen, touch Options, then touch Info. To update the firmware to the appropriate version, use either a USB flash drive or an Ethernet connection, as described in the next sections.

---

**IMPORTANT!** Ensure that the latest firmware is installed on the Ion OneTouch™ 2 Instrument. However, if you are using the Ion PGM™ Template OT2 200 Kit together with the Ion PGM™ Hi-Q™ Sequencing Kit, do not upgrade to Torrent Suite™ Software v5.0 or later until you no longer require the mixed workflow. The OT2 program script enabling the mixed workflow is discontinued in v5.0. We recommend using the Ion PGM™ Hi-Q™ OT2 Kit (Cat. no. A27739) together with the Ion PGM™ Hi-Q™ Sequencing Kit.

---

## Initialize the Ion OneTouch™ 2 Instrument

---

**IMPORTANT!** Before operating the Ion OneTouch™ 2 Instrument for the first time, you must perform the one-time initialization on the instrument. Initialization primes the pumps and tubing lines for reliable operation. Perform initialization at any time before the first run.

---

For detailed instructions on initialization of the Ion OneTouch™ 2 Instrument, see “Initialize the Ion OneTouch™ 2 Instrument” on page 101.

## Perform a verification run

To ensure optimal use of the Ion OneTouch™ 2 System, we recommend first preparing and enriching template-positive Ion PGM™ Template OT2 200 Ion Sphere™ Particles (ISPs) on the system with a control library.

1. Obtain the *E. coli* DH10B Control Library bag from the Ion PGM™ Controls Kit v2 (Cat. no. 4482010) and use the *E. coli* DH10B Control 200 Library.
2. Dilute 1 µL of control library into 259 µL of Nuclease-free Water in an Eppendorf LoBind™ Tube. Use 25 µL of the dilution in the amplification solution (see “Prepare and install the amplification solution” on page 26).
3. Follow the operating instructions to set up and use the Ion OneTouch™ 2 Instrument to prepare template-positive ISPs and to use the Ion OneTouch™ ES to prepare enriched ISPs (see “Set up the Ion OneTouch™ 2 Instrument” on page 18).
4. If you have a Qubit™ 2.0 or Qubit™ 3.0 System, determine the percent template-positive ISPs (see Appendix B, “Quality control of Ion PGM™ Template OT2 200 ISPs”). If you do not have one of these instruments, proceed to step 5.



5. Sequence the control library on the Ion PGM™ System using the Ion 314™ Chip v2 (Cat. no. 4482261). Set the Ion PGM™ Sequencer to 500 flows. Load the sample, then analyze the results.

**Note:** Use the Ion PGM™ Sequencing 200 Kit v2 (Cat. no. 4482006). Refer to the *Ion PGM™ Sequencing 200 Kit v2 User Guide* (Pub. no. MAN0007273).

6. Review the run report from the Torrent browser and confirm successful sequencing results with the control library. The AQ20 result of the template-positive ISPs must be >20 Mb with the Ion 314™ Chip v2.

**Note:** If the AQ20 result is ≤20 Mb with the Ion 314™ Chip v2, sequence the control library again and measure AQ20. If the AQ20 result is still not satisfactory, contact Technical Support.

7. The instrument is ready for use.

# 3

## Prepare template-positive Ion PGM™ Template OT2 200 ISPs

■ Set up the Ion OneTouch™ 2 Instrument .....	18
■ Prepare and install the amplification solution .....	26
■ Run the Ion OneTouch™ 2 Instrument .....	32
■ Recover the template-positive Ion PGM™ Template OT2 200 ISPs .....	35
■ Maintain the Ion OneTouch™ 2 Instrument .....	38

### Set up the Ion OneTouch™ 2 Instrument

- If this is the first use of the instrument, perform the one-time initialization procedure (see “Initialize the Ion OneTouch™ 2 Instrument” on page 101) at any time before the first run.



In addition, re-initialization is recommended when switching between kits with different lots of Ion OneTouch™ Oil.

**Note:** To set up the Ion OneTouch™ 2 Instrument when switching between sequencing platforms, refer to the *Ion OneTouch™ 2 System User Guide* (Pub. no. MAN0014388).

- If this is the first run after initialization, proceed to “Prepare and install the amplification solution” on page 26. The instrument consumables are already installed and ready for the run.

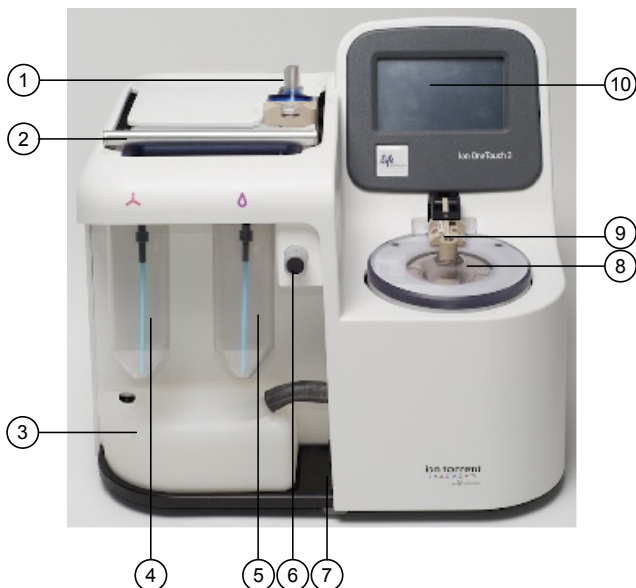
## Ion OneTouch™ 2 Instrument layout



- |  |   |
|--|---|
| ① Ion PGM™ OneTouch Plus Reaction Filter Assembly  | ⑥ Pinch valve to hold disposable tubing                     |
| ② Clamp handle to access the Amplification Plate in the heat block   | ⑦ Oil waste tray  |
| ③ Waste Container  | ⑧ Centrifuge to spin the Recovery Tubes and Recovery Router |
| ④ Ion OneTouch™ Oil               | ⑨ Ion OneTouch™ DL Injector Hub                             |
| ⑤ Ion PGM™ OT2 Recovery Solution  | ⑩ Instrument display  |

**Note:** The photograph does not show the disposable tubing.

### Materials required for this procedure

#### Provided in Ion PGM™ Template OT2 Supplies 200 Kit (Part no. 4480981):

- 2 Ion OneTouch™ Reagent Tubes
- Ion OneTouch™ Recovery Router
- 2 Ion OneTouch™ Recovery Tubes
- Ion OneTouch™ 2 Amplification Plate
- 2 Ion OneTouch™ Sipper Tubes

#### Provided in Ion PGM™ Template OT2 Solutions 200 Kit (Part no. 4481105):

- Ion OneTouch™ Oil (450 mL size)
- Ion PGM™ OT2 Recovery Solution

**Note:** We have verified this protocol using only the material specified. Substitution may adversely affect performance and safety.

---

**IMPORTANT!** Use *only* the Ion PGM™ Template OT2 200 Kit (Cat. no. 4480974) with this user guide and with the Ion OneTouch™ 2 System. Do *not* mix reactions or disposables including plates, solutions, and kit reagents from other template preparation kits.

---

### Install the Ion OneTouch™ Recovery Tubes and Ion OneTouch™ Recovery Router

1. On the instrument display, touch **Open Lid**, wait until the lid clicks open, then lift and hold the side of the centrifuge lid.

---

**IMPORTANT!** Do *not* lift the lid by the tubing attached to the Ion OneTouch™ DL Injector Hub. Do *not* force the lid open.

---

2. Insert a Recovery Tube into each slot of the centrifuge:

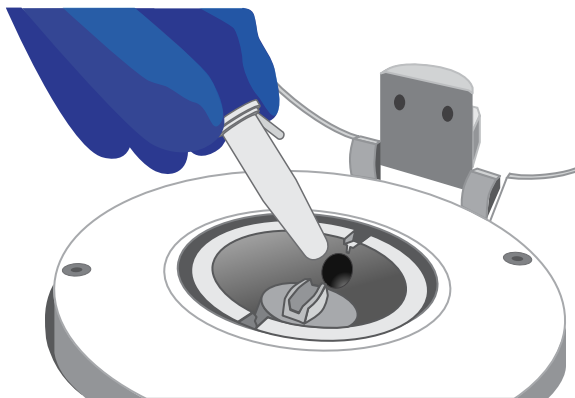

3. Slide the Recovery Router in position around each Recovery Tube extension. Pinch the sides of the Recovery Router and push it down into the center slot of the centrifuge. The Recovery Router must be seated flat and secure in the center of the rotor:

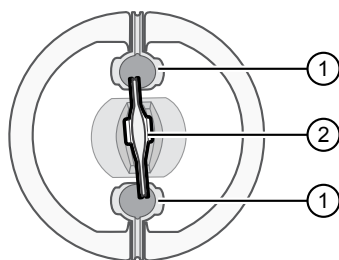

- ① Ion OneTouch™ Recovery Tube
- ② Ion OneTouch™ Recovery Router

4. Close the lid of the centrifuge.

## Install the Ion OneTouch™ 2 Amplification Plate

1. If there is a used Ion OneTouch™ 2 Cleaning Adapter on the instrument, remove and appropriately discard it.

**Note:** The Cleaning Adapter may be filled with Ion OneTouch™ Oil.

2. Push the handle back to open the heat block.



**CAUTION! Hot Surface.** Use care when working around this area to avoid being burned by hot components.

---



**WARNING! Safety Hazard.** Do not use the instrument with flammable or explosive materials. Use only the materials specified for use with the instrument to ensure safety.

---

3. Insert the Amplification Plate:
  - a. Inspect the Amplification Plate to ensure that the plate port is straight and perpendicular to the plate.

**IMPORTANT!** The disposable tubing and disposable injector are attached to the Amplification Plate. Do *not* disconnect tubing from the top plate port. If you have questions about the plate, contact Technical Support.

---

- b. Hold the disposable injector, connected to the disposable tubing, in one hand and the Amplification Plate in the other hand.



**CAUTION! PHYSICAL INJURY HAZARD.** The pointed end of the disposable injector can puncture your skin. Keep your hand away from the point of the disposable injector.

---

- c. Insert the Amplification Plate into the heat block so that the single plate port aligns with the *left* hole of the Ion OneTouch™ 2 Instrument:

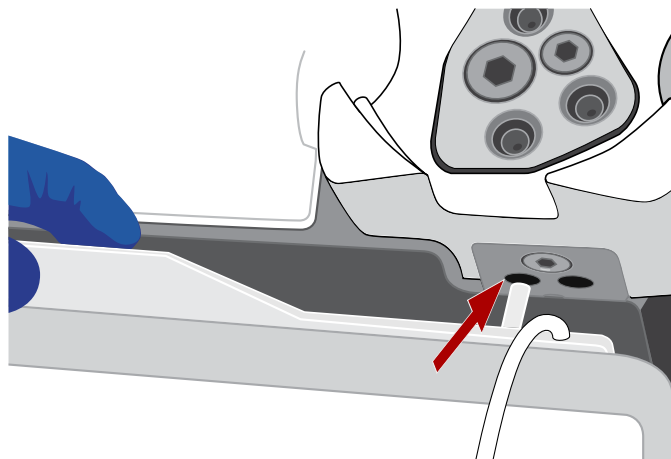

4. Pull the handle of the heat block to close the block, then thread the disposable tubing through the Ion OneTouch™ DL Tubing Catch:

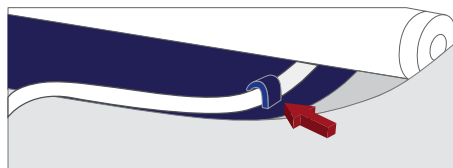

**Note:** The disposable tubing is under the handle.

5. Install the disposable tubing in the pinch valve:
  - a. Align the disposable tubing with the slot that runs along the bottom of the pinch valve.
  - b. Gently pull the disposable tubing upwards on the both sides of the pinch valve until the disposable tubing is in the slot and secured in the round notch on each side of the pinch valve:

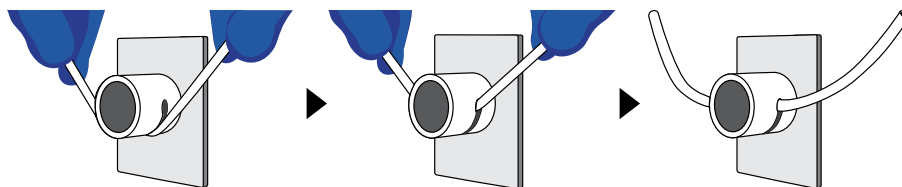

- c. If necessary, adjust the disposable tubing along the notches of the open pinch valve so that there is sufficient length of disposable tubing to install the disposable injector (see “Install the disposable injector” on page 23).

## Install the disposable injector

**Note:** Before use, inspect the long metal shaft of the disposable injector. Some disposable injectors may be slightly bent, which is normal. If you have questions about the disposable injector, contact Technical Support.

1. Place one hand on the centrifuge lid. Place the other hand at the top of the disposable injector, and insert the disposable injector straight into the port of the Ion OneTouch™ DL Injector Hub:



**CAUTION! PHYSICAL INJURY HAZARD.** The pointed end of the disposable injector can puncture your skin. Keep your hand away from the point of the disposable injector.



**Note:** The color of the disposable injector may vary.

2. Keep your hand on the centrifuge lid, then push the disposable injector through the port until the disposable injector just stops at the base of the router:
3. Release the disposable injector.
4. Confirm automatic placement of the disposable injector above the router. Briefly press then release the spring-loaded top of the Injector Hub at the point indicated by the arrows in Figures a–c. You should hear a click:



**a (up position)**



**b (down position)**

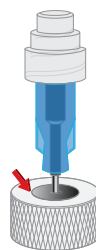

**c (up position)**

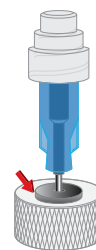

---

**IMPORTANT!** If the Injector Hub remains in the down position, see Appendix A, “Troubleshooting”.

---

**IMPORTANT!** If you raise the centrifuge lid, do not hit the disposable injector against the instrument. You can damage the disposable injector. If you damage the disposable injector, appropriately dispose of the injector, amplification plate, and tubing. Use a new disposable injector and Ion OneTouch™ 2 Amplification Plate.

---

## Install the Ion OneTouch™ Oil

Fill the appropriate Ion OneTouch™ Reagent Tube with Ion OneTouch™ Oil on the left front port :

If you are...	Then...
Using a new Template Kit	<ol style="list-style-type: none"> <li>1. Use a new Reagent Tube from the kit.</li> <li>2. Discard the used Reagent Tube and Sipper Tube. Appropriately discard the residual Oil.</li> <li>3. Use fresh gloves to attach the Luer-Lok™ end of a new Ion OneTouch™ Sipper Tube to the <i>left</i> front port. Do <b>not</b> let the Sipper Tube touch any surface.</li> <li>4. Invert the Ion OneTouch™ Oil bottle (450-mL size) 3 times to mix, then fill the Reagent Tube <i>half</i>-full with Oil. Minimize bubbles.</li> <li>5. Insert the filled Reagent Tube into the <i>left</i> front port, and screw the Reagent Tube firmly into place, one-quarter turn on the instrument.</li> </ol>
Refilling the Reagent Tube between runs	<ol style="list-style-type: none"> <li>1. Remove the Reagent Tube from the instrument.</li> <li>2. Invert Ion OneTouch™ Oil bottle (450-mL size) 3 times to mix.</li> <li>3. Fill the Reagent Tube <i>half</i>-full with Oil. Minimize bubbles.</li> </ol> <p><b>Note:</b> It is not necessary to re-mix the Oil.</p> <ol style="list-style-type: none"> <li>4. Insert the filled Reagent Tube into the <i>left</i> front port, and screw the Reagent Tube firmly into place, one-quarter turn on the instrument.</li> </ol>



## Install the Ion PGM™ OT2 Recovery Solution

**IMPORTANT!** Use only the Ion PGM™ OT2 Recovery Solution provided as part of the Ion PGM™ Template OT2 200 Kit for the Ion OneTouch™ 2 Instrument. Do *not* use a different recovery solution from another kit.

1. Ensure that the Recovery Solution is clear. If it is clear, proceed to the next step. If the Recovery Solution is not clear, heat the bottle of Recovery Solution in a 30°C bath until the Recovery Solution is clear.
2. Fill the appropriate Ion OneTouch™ Reagent Tube with Ion PGM™ OT2 Recovery Solution on the right front port :

If you are...	Then...
Using a new Template Kit	<ol style="list-style-type: none"> <li>1. Use a new Reagent Tube from the kit.</li> <li>2. Discard the used Reagent Tube and Sipper Tube. Appropriately discard the Recovery Solution.</li> <li>3. Use fresh gloves to attach the Luer-Lok™ end of a new Ion OneTouch™ Sipper Tube to the <i>right</i> front port. Do not let the Sipper Tube touch any surfaces.</li> <li>4. Invert the Recovery Solution 3 times to mix, then fill the Reagent Tube <i>a quarter</i>-full with Recovery Solution. Minimize bubbles.</li> <li>5. Insert the filled Reagent Tube into the <i>right</i> front port, and screw the Reagent Tube firmly into place, one-quarter turn on the instrument.</li> </ol>
Refilling the Reagent Tube between runs	<ol style="list-style-type: none"> <li>1. Remove the Reagent Tube from the instrument.</li> <li>2. Invert the bottle of Recovery Solution 3 times.</li> <li>3. Add more Recovery Solution to the solution in the Reagent Tube until the tube is <i>a quarter</i>-full. Minimize bubbles.</li> <li>4. Insert the filled Reagent Tube into the <i>right</i> front port, and screw the Reagent Tube firmly into place, one-quarter turn on the instrument.</li> </ol>

## Empty the Waste Container

1. Pull the external tubing from the port of the Waste Container.
2. Empty the Waste Container into the appropriate receptacle.
3. Reinstall the empty Waste Container.

## Prepare and install the amplification solution

### Prepare the amplification solution

**IMPORTANT!** Use *only* the Ion PGM™ Template OT2 200 Kit (Cat. no. 4480974) with this user guide and with the Ion OneTouch™ 2 Instrument. Do not use the kit with the Ion OneTouch™ System. Do **not** mix reactions or disposables including plates, solutions, and kit reagents from other template preparation kits.

**IMPORTANT!** We recommend preparing the amplification solution in a room dedicated to pre-PCR activities or in a controlled pre-PCR hood.

1. Prepare the reagents as follows:

Reagents	Preparation
Ion PGM™ Template OT2 200 Reagent Mix	<ol style="list-style-type: none"> <li>1. Allow the reagent mix to come to room temperature before use.</li> <li>2. Vortex the solution for 30 seconds, then centrifuge the solution for 2 seconds.  <b>Note:</b> Visually inspect the solution at the bottom of the tube and verify that there is no residual precipitate. If precipitate is visible, refer to Appendix A, "Troubleshooting".</li> <li>3. Keep the reagent mix at room temperature during use. Store thawed reagent mix at 2°C to 8°C.</li> </ol>
Ion PGM™ Template OT2 200 PCR Reagent B	<ol style="list-style-type: none"> <li>1. Vortex the reagent for 1 minute, then centrifuge the solution for 2 seconds.</li> <li>2. Inspect the reagent: <ul style="list-style-type: none"> <li>• If the solution is <i>clear</i>, then prepare the amplification solution. Keep Reagent B at room temperature.</li> <li>• If the solution is <i>cloudy</i> or has crystals or has been accidentally stored at 2°C to 8°C, heat the reagent for 1 minute in a heat block set at 75°C. Vortex the reagent for 1 minute, then centrifuge the solution for 2 seconds.</li> </ul> </li> <li>3. Inspect the reagent. If the reagent is: <ul style="list-style-type: none"> <li>• <i>Cloudy</i> or has <i>crystals</i>: repeat steps 1–2 until the reagent is clear, then equilibrate the reagent to room temperature and prepare the amplification solution.</li> <li>• <i>Clear</i>: Equilibrate the reagent to room temperature, then prepare the amplification solution. Store Reagent B at room temperature. <b>IMPORTANT!</b> Do not use the reagent if it is cloudy or has crystals.</li> </ul> </li> </ol>
Ion PGM™ Template OT2 200 Enzyme Mix	<ol style="list-style-type: none"> <li>1. Centrifuge the enzyme for 2 seconds.</li> <li>2. Place on ice.</li> </ol>

Reagents	Preparation
Ion PGM™ Template OT2 200 Ion Sphere™ Particles	Place the suspension at room temperature.

**IMPORTANT!** Use only Ion PGM™ Template OT2 200 Ion Sphere™ Particles (ISPs) in the Ion PGM™ Template OT2 200 Kit with the Ion OneTouch™ 2 System. Do *not* use ISPs from other or previously used kits.

- Depending on your library type and concentration, dilute the library as shown in the table below. Use the library dilution within 48 hours of preparation.

**Note:** If you are troubleshooting the amplification process, to 260 µL of Nuclease-free Water, add 1 µL of the *E. coli* DH10B Control 200 Library from the Ion PGM™ Controls Kit v2 (Cat. no. 4482010).

	Ion AmpliSeq™ DNA Library	Ion AmpliSeq™ RNA Library	gDNA Fragment or Amplicon Library	Ion Total RNA-Seq Library
Library concentration	100 pM	100 pM	100 pM	100 pM
Volume of library	2 µL	4 µL	6.5 µL	5 µL
Volume of Nuclease-free Water	23 µL	21 µL	18.5 µL	20 µL
<b>Total volume of diluted library to add to the amplification solution</b>	<b>25 µL</b>	<b>25 µL</b>	<b>25 µL</b>	<b>25 µL</b>

- Vortex the diluted library for 5 seconds, then centrifuge for 2 seconds.
  - Place the diluted library on ice.
- In a 1.5-mL Eppendorf LoBind™ Tube at 15°C to 30°C, add the following components in the designated order (You add the ISPs in step 6 of this procedure.) Add each component, then pipet the amplification solution up and down to mix:

Order	Reagent	Cap color	Volume
1	Nuclease-free Water	—	25 µL
2	Ion PGM™ Template OT2 200 Reagent Mix	Violet	500 µL
3	Ion PGM™ Template OT2 200 PCR Reagent B	Blue	300 µL
4	Ion PGM™ Template OT2 200 Enzyme Mix	Brown	50 µL
5	Diluted library ( <i>not</i> stock library)	—	25 µL
—	<b>Total</b>	—	<b>900 µL</b>

4. Vortex the solution prepared in step 3 at maximum speed for 5 seconds, then centrifuge the solution for 2 seconds.
5. Prepare the Ion PGM™ Template OT2 200 Ion Sphere™ Particles:
  - a. Vortex the ISPs at maximum speed for *1 minute* to resuspend the particles.
  - b. Centrifuge the ISPs for 2 seconds.
  - c. Pipet the ISPs up and down to mix.
  - d. *Immediately* proceed to the next step.
6. Add the ISPs to the amplification solution:

Order	Reagent	Cap Color	Volume
1	Amplification solution <i>without</i> ISPs (from step 3 of this procedure)	—	900 µL
2	Ion PGM™ Template OT2 200 Ion Sphere™ Particles	Black	100 µL
—	<b>Total</b>	—	<b>1000 µL</b>

7. Vortex the complete amplification solution prepared in step 6 at maximum speed for 5 seconds.

---

**IMPORTANT!** Start the run on the Ion OneTouch™ 2 Instrument ≤15 minutes after preparing the amplification solution.

---

8. Proceed *immediately* to “Fill the Ion PGM™ OneTouch Plus Reaction Filter Assembly” on page 29.

## Fill the Ion PGM™ OneTouch Plus Reaction Filter Assembly

**IMPORTANT!** We recommend filling the Ion PGM™ OneTouch Plus Reaction Filter Assembly in a room dedicated to pre-PCR activities or in a controlled pre-PCR hood. Do *not* use a reaction filter assembly from any other template preparation kit.

1. Obtain an Ion PGM™ OneTouch Plus Reaction Filter Assembly from the Ion PGM™ Template OT2 200 Kit:

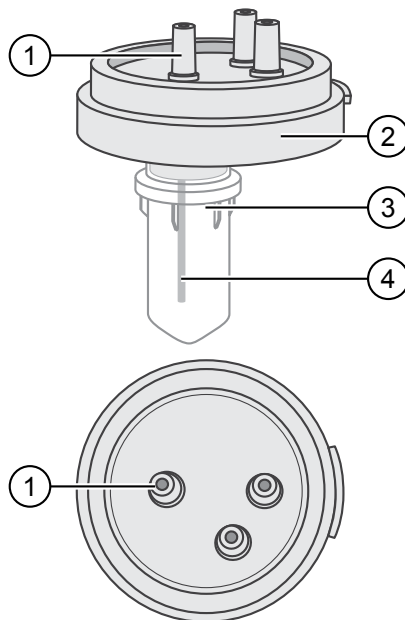

- ① Sample port
- ② Ion PGM™ OneTouch Plus Reaction Filter Assembly
- ③ Ion OneTouch™ Reaction Tube
- ④ Short tubing from sample port to Ion OneTouch™ Reaction Tube

2. Place the Ion PGM™ OneTouch Plus Reaction Filter Assembly into a tube rack so that the 3 ports of the Ion PGM™ OneTouch Plus Reaction Filter Assembly face *up*.
3. Identify the sample port on the Ion PGM™ OneTouch Plus Reaction Filter Assembly. The short tubing in the Reaction Tube is connected to the sample port:  
**Note:** The color of the short tubing attached to the sample port may vary.
4. Add the amplification solution through the sample port:
  - a. Set a P1000 pipette to 1000  $\mu$ L, and attach a new 1000- $\mu$ L tip to the pipette.
  - b. Vortex the amplification solution at maximum speed for **a full 5 seconds**, then centrifuge the solution for 2 seconds. *Immediately* proceed to the next step.
  - c. Pipet the amplification solution up and down to mix, then fill the tip with 1000  $\mu$ L of the amplification solution.

- d. Insert the tip firmly into the sample port so that the tip is perpendicular to the Ion OneTouch™ Reaction Filter Assembly and fully inserted into the sample port to form a tight seal:

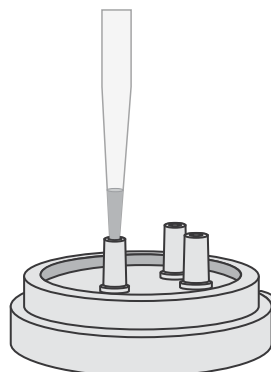

- e. Slowly pipet the 1 mL of amplification solution through the sample port. Keep the plunger of the pipette depressed to avoid aspirating solution from the Ion PGM™ OneTouch Plus Reaction Filter Assembly. With the plunger still depressed, remove the tip from the sample port, then appropriately discard the tip.
  - f. If necessary, gently dab a Kimwipes™ disposable wipe around the ports to remove any liquid.
5. Add 1.5 mL Ion OneTouch™ Reaction Oil (27-mL size) through the sample port:
    - a. Set a P1000 pipette to 1000  $\mu$ L, and attach a new 1000- $\mu$ L tip to the pipette.
    - b. Draw up 1000  $\mu$ L of Ion OneTouch™ Reaction Oil into the pipette tip.
    - c. Insert the tip firmly into the sample port so that the tip is perpendicular to the Ion PGM™ OneTouch Plus Reaction Filter Assembly and forms a tight seal.
    - d. Slowly pipet the 1000  $\mu$ L of Reaction Oil through the sample port, then keep the plunger of the pipette depressed.
    - e. With the plunger depressed, remove the tip from the sample port. Appropriately discard the tip.
    - f. Set the P1000 pipette to 500  $\mu$ L, and attach a new 1000- $\mu$ L tip to the pipette. Slowly pipet 500  $\mu$ L of the Reaction Oil through the sample port, then keep the plunger of the pipette depressed.
    - g. Draw up 500  $\mu$ L of Ion OneTouch™ Reaction Oil into the pipette tip.
    - h. Insert the tip firmly into the sample port so that the tip is perpendicular to the Ion PGM™ OneTouch Plus Reaction Filter Assembly and forms a tight seal.
    - i. Slowly pipet the 500  $\mu$ L of Reaction Oil through the sample port, then keep the plunger of the pipette depressed.

- j. With the plunger depressed, remove the tip from the sample port, then appropriately discard the tip.
- k. If necessary, gently dab a Kimwipes™ disposable wipe around the ports to remove any liquid.

### Install the filled Ion PGM™ OneTouch Plus Reaction Filter Assembly

1. Invert the Ion PGM™ OneTouch Plus Reaction Filter Assembly:

---

**IMPORTANT!** Follow the next steps exactly to minimize contact of the short tubing in the Reaction Tube with the amplification solution.

---

- a. Keep the Ion PGM™ OneTouch Plus Reaction Filter Assembly in the tube rack, orient the assembly so that the sample port is on your *left*:
- b. Lift straight out the Ion PGM™ OneTouch Plus Reaction Filter Assembly from the tube rack. With the short tubing in the Reaction Tube on the left, rotate the assembly to your *right* until the Reaction Tube is inverted and the 3 ports of the Reaction Plus Filter face *down*:

---

**IMPORTANT!** Correct rotation of the Ion PGM™ OneTouch Plus Reaction Filter Assembly ensures minimal exposure of the short tubing in the Reaction Tube with the amplification solution.

---

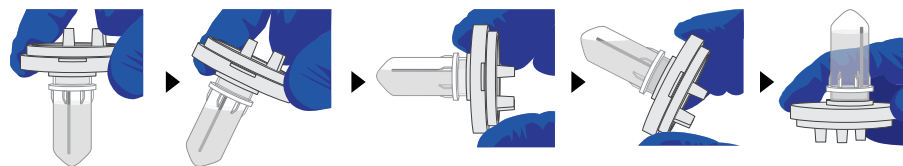

2. Insert the 3 ports of the Reaction Filter into the three holes (left) on the top stage of the Ion OneTouch™ 2 Instrument, so that the Ion PGM™ OneTouch Plus Reaction Filter Assembly is firmly seated (right) on the instrument. The tab protruding from the outer edge of the Reaction Filter fits into the front notch of the stage:

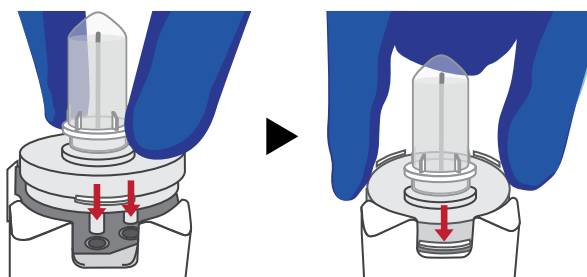

**Note:** After inserting the Ion PGM™ OneTouch Plus Reaction Filter Assembly, bubbles may shoot up into the Reaction Tube.

## Run the Ion OneTouch™ 2 Instrument

**Note:** Ensure that you have the correct firmware update for your system (see “Check the firmware” on page 16).

1. Ensure that the centrifuge lid of the Ion OneTouch™ 2 Instrument is closed.

---

**IMPORTANT!** If you raise the centrifuge lid, do not hit the disposable injector against the instrument. You can damage the disposable injector. If you damage the disposable injector, appropriately dispose of the injector, amplification plate, and tubing. Use a new disposable injector and Ion OneTouch™ 2 Amplification Plate.

---

2. On the home screen, touch **Run**:

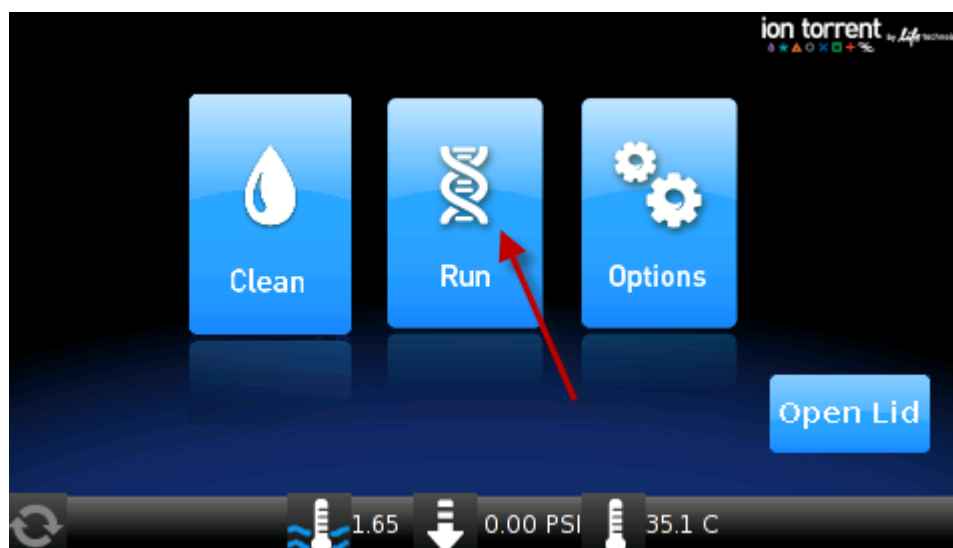



3. Touch the drop-down menu, then select **PGM: Ion PGM™ Template OT2 200 Kit** :

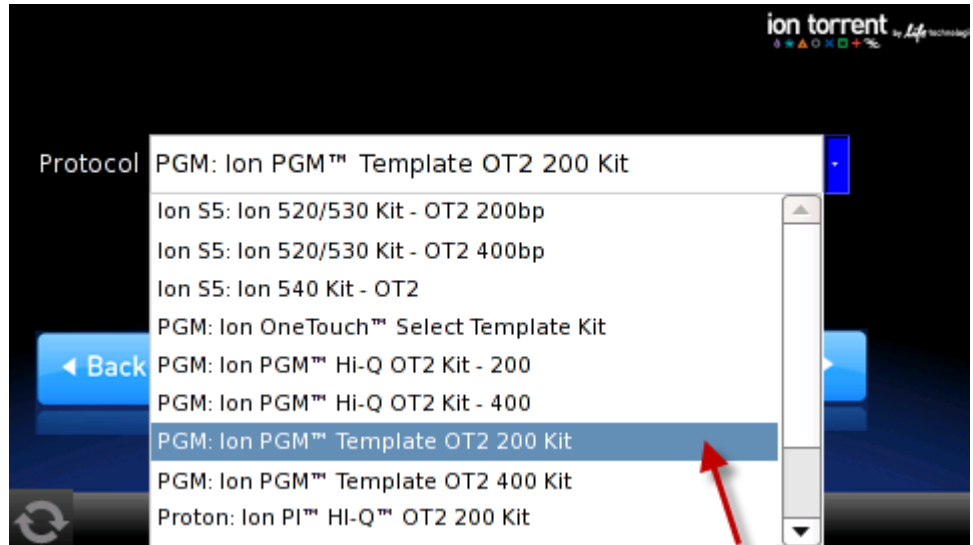

**Note:** The **PGM: Ion PGM™ Template OT2 200 Kit for Hi-Q** program is discontinued in Torrent Suite™ Software v5.0. We recommend that you use the Ion PGM™ Hi-Q™ OT2 Kit (Cat. no. A27739) with the Ion PGM™ Hi-Q™ Sequencing Kit.

4. Touch **Next**.

### 5. Touch **Assisted** or **Expert**:

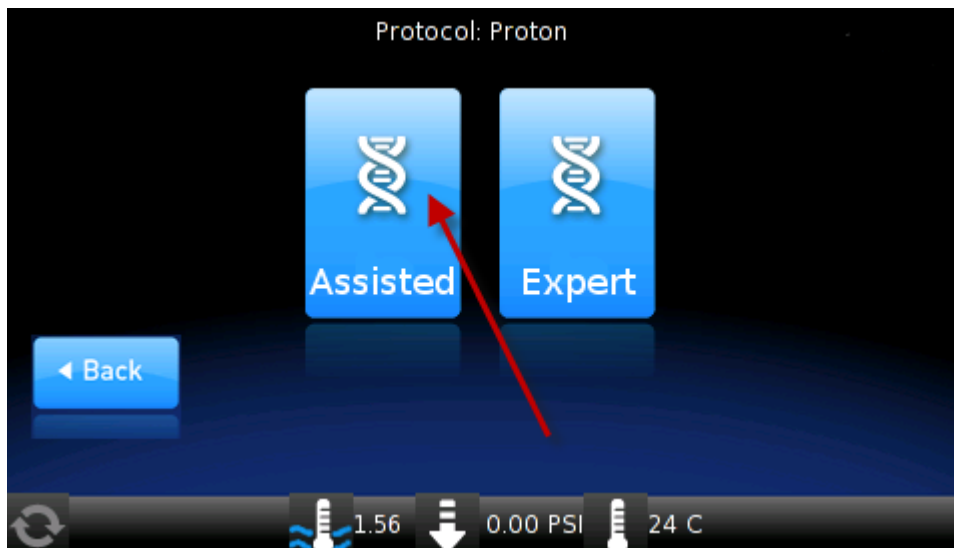

- **Assisted** run. Complete each task, then touch **Next**. After you touch **Next** on the last task, you see a progress bar, and the run begins. After the run starts, you hear clicks from the instrument. This is normal.
- **Expert** run. Empty the waste container and oil waste tray, if necessary, then touch **Next**. You see a progress bar, and the run begins without the list of task screens.

---

**IMPORTANT!** To cancel a run, touch **Abort**, then touch **Yes** to confirm cancellation. If there is a high-pressure event on the instrument, the instrument aborts the run *automatically*, and you do *not* have to touch **Abort**.

After a run is aborted, follow these steps in this order:

Ion PGM™

- Download the log files for troubleshooting by Technical Support (see “Download the log files from the Ion OneTouch™ 2 Instrument” on page 109).
  - Turn OFF the instrument.
  - If necessary, retain all consumables on the instrument for troubleshooting.
  - After successful troubleshooting, appropriately dispose of all used consumables and turn ON the instrument.
  - Set up the instrument with new kit components (see “Set up the Ion OneTouch™ 2 Instrument” on page 18).
  - Prepare a new amplification solution (see “Prepare and install the amplification solution” on page 26).
  - Start a new run.
- 
6. Remove the samples  $\leq 16$  hours after starting the run. If you touched **Next** on the Centrifuge screen to centrifuge samples at the end of the run, proceed *immediately* to “Recover the template-positive Ion PGM™ Template OT2 200 ISPs”.

## Recover the template-positive Ion PGM™ Template OT2 200 ISPs

### Materials required for this procedure

Provided in Ion PGM™ Template OT2 Solutions 200 Kit (Part no. 4481105):

Ion OneTouch™ Wash Solution

### Other Materials and Equipment:

- 1.5 mL Eppendorf LoBind™ Tubes
- Pipettes
- Vortexer
- Microcentrifuge

### Recover the template-positive ISPs

1. At the end of the run, follow the screen prompts to centrifuge the sample. If you removed the Reaction Tubes at the end of the run *before* the Ion OneTouch™ 2 Instrument had spun the sample or have not processed the sample after 15 minutes, centrifuge the sample on the instrument:
  - a. On the home screen of the instrument, touch **Open Lid**, wait until the lid clicks open, then insert the two filled Ion OneTouch™ Recovery Tubes from the run in the centrifuge rotor. Close the lid until it locks.
  - b. Touch **Options** ▶ **Final Spin** (see figure below), then follow the screen prompts (touch **Next** on the next 2 screens) until the centrifugation begins. Centrifugation of the samples takes 10 minutes.

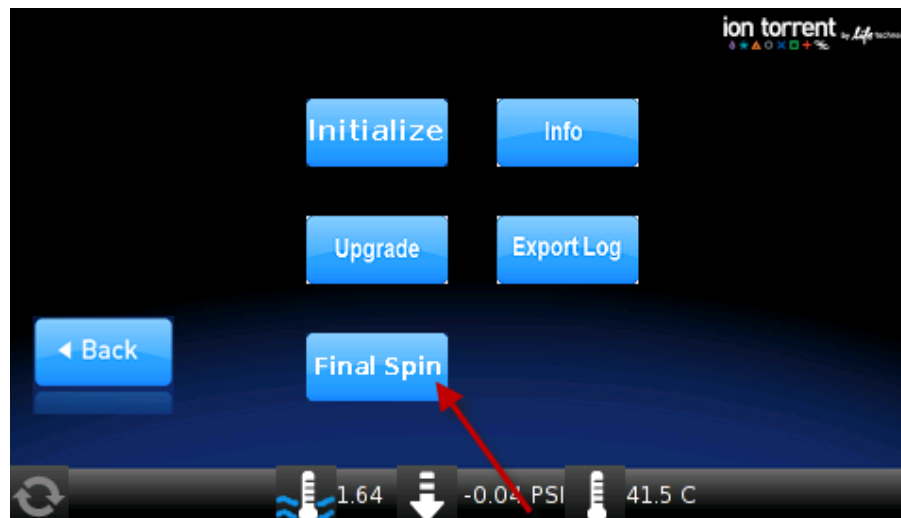

- c. *Immediately* proceed to step 2.



**CAUTION! ROTATION HAZARD.** Wait until rotation stops before opening. Rotating parts can cause injury.

2. Immediately after the centrifuge has stopped, on the instrument display, touch **Open Lid**. Wait until the lid clicks open, then remove and discard the Ion OneTouch™ Recovery Router.

3. Carefully remove both Ion OneTouch™ Recovery Tubes from the instrument and put the two Recovery Tubes in a tube rack. You may see some cloudiness in the tube, which is normal.
4. Remove excess Ion PGM™ OT2 Recovery Solution from the ISPs:
  - a. Use a pipette to remove all but 50 µL of the Recovery Solution from each Recovery Tube. Withdraw the supernatant from the surface and on the opposite side from the pellet. Remove any white flocculent material. Do not disturb the ISP pellet:

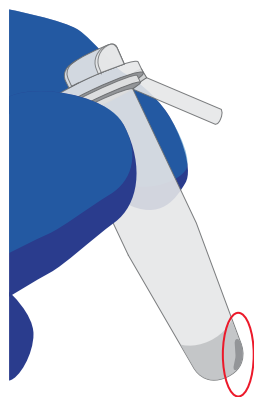

- b. With a new tip and using the same tip for both tubes, resuspend the ISPs in the remaining Ion PGM™ OT2 Recovery Solution. Pipet the pellet up and down until each pellet disperses in the solution.

---

**STOPPING POINT** Combine the suspension from each Recovery Tube into one new 1.5-mL Eppendorf LoBind™ Tube for a total of 100 µL. Add 1 mL of Ion OneTouch™ Wash Solution to the 100-µL ISP suspension. Store the ISPs at 2°C to 8°C for up to 3 days. If the template-positive ISPs were stored at 2°C to 8°C, centrifuge the ISPs at 15,500 × g for 2.5 minutes, then carefully remove all but 100 µL of supernatant. With a new tip, pipet up and down to resuspend the ISPs. Proceed to step 5.

---

5. Obtain an 8-well strip from the Ion OneTouch™ ES Supplies Kit. Ensure that the square-shaped tab of an 8-well strip is on the left:

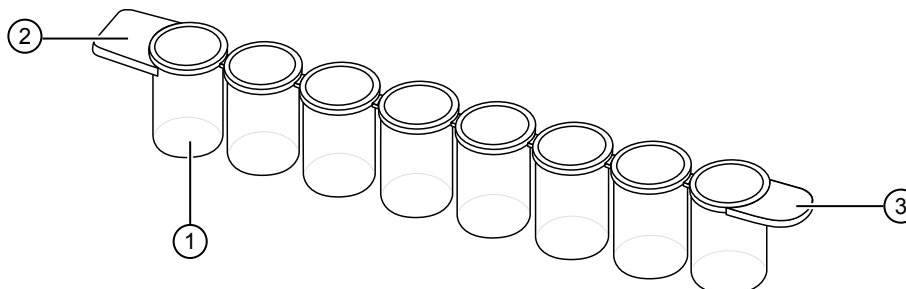

- ① Well 1
- ② Square-shaped tab
- ③ Rounded tab

6. Pipet the ISPs up and down 10 times to mix, then transfer the suspensions from both tubes (1 tube if stored) into Well 1 of the 8-well strip for a total of 100 µL of ISP suspension in the well.
7. Retain an aliquot of the unenriched Ion PGM™ Template OT2 200 Kit from Well 1 for quality assessment. Assess the quality of the unenriched, template-positive ISPs using one of the following methods:

Quality assessment by...	Then...
Qubit™ 2.0 or Qubit™ 3.0 Fluorometer	Transfer a 2.0-µL aliquot of the unenriched ISPs to a 0.2-mL PCR Tube, then see “Quality control using the Qubit™ 2.0 Fluorometer” on page 57, or “Quality control using the Qubit™ 3.0 Fluorometer” on page 70.
<i>(Optional)</i> Guava™ easyCyte™ 5 Flow Cytometer	Transfer a 1.0-µL aliquot of the unenriched ISPs to a 1.5-mL Eppendorf LoBind™ Tube. Refer to the <i>Ion Sphere™ Particles (ISPs) Quality Assessment Using the Guava™ easyCyte™ 5 Flow Cytometer User Bulletin</i> (Pub. no. 4470082), available on the Ion Community website: <a href="http://ioncommunity.thermofisher.com">ioncommunity.thermofisher.com</a>
Demonstrated protocol: Quality assessment by the Applied Biosystems™ Attune™ Acoustic Focusing Cytometer	Transfer a 1.0-µL aliquot of the unenriched ISPs to a 1.5-mL microcentrifuge tube. Put the sample on ice, then refer to <i>Demonstrated Protocol: Ion Sphere™ Particles (ISPs) Quality Assessment using the Applied Biosystems™ Attune™ Acoustic Focusing Cytometer User Bulletin</i> (Pub. no. 4477181), available on the Ion Community website: <a href="http://ioncommunity.thermofisher.com">ioncommunity.thermofisher.com</a>

8. Enrich the template-positive ISPs (see Chapter 4, “Enrich the template-positive Ion PGM™ Template OT2 200 ISPs”).

---

**IMPORTANT!** Do not store the recovered, template-positive ISPs at –30°C to –10°C. Do not store the ISPs in Ion PGM™ OT2 Recovery Solution (see Step 4 of this procedure).

---

## Maintain the Ion OneTouch™ 2 Instrument

**IMPORTANT!** Follow the cleaning procedure in this section to clean the Ion OneTouch™ 2 Instrument with the Ion OneTouch™ 2 Cleaning Adapter. *Perform the cleaning procedure after every run. Do not skip this procedure.* The cleaning procedure is performed according to the steps displayed on the instrument after removing the Recovery Tubes.

**Note:** To set up the Ion OneTouch™ 2 Instrument when switching between sequencing platforms and/or template preparation kits, refer to Chapter 5 of the *Ion OneTouch™ 2 System User Guide* (Pub. no. MAN0014388).

### Materials required for this procedure

**Provided in Ion PGM™ Template OT2 Supplies 200 Kit (Part no. 4480981):**

Ion OneTouch™ 2 Cleaning Adapter (single-use)

**Provided in Ion PGM™ Template OT2 Solutions 200 Kit (Part no. 4481105):**

Ion OneTouch™ Oil

**Other Materials and Equipment:**

- Kimwipes™ disposable wipes
- 50-mL conical tube
- Tube rack for 50-mL conical tube

**Note:** To ensure continued safe operation, visually inspect the rotor assembly and casing periodically to ensure there are no signs of cracks or other physical damage (see “Ion OneTouch™ 2 Instrument layout” on page 19).

### Clean the Ion OneTouch™ 2 Instrument

1. Determine the appropriate reagents to use for maintaining the Ion OneTouch™ 2 Instrument:

If you are...	Then...
Switching to the Ion PGM™ Template OT2 200 Kit from another kit?	Refer to Chpt. 5 of the <i>Ion OneTouch™ 2 System User Guide</i> (Pub. no. MAN0014388). Use the reagents from the appropriate kit to maintain the Ion OneTouch™ 2 Instrument.
Already using the Ion PGM™ Template OT2 200 Kit.	Proceed to step 2. Continue to use the reagents provided in the Ion PGM™ Template OT2 200 Kit.

2. Check the level of Ion OneTouch™ Oil in the Reagent Tube:
  - a. Ensure that the *left* Reagent Tube has  $\geq 20$  mL of Oil:
  - b. If the Reagent Tube has  $< 20$  mL of Oil, pour Oil into the Reagent Tube until it is half-full.
3. Remove and appropriately discard the used Ion PGM™ OneTouch Plus Reaction Filter Assembly. Remove the assembly from the instrument by grasping the *filter*.

**Note:** The Reaction Tube is filled with Ion OneTouch™ Oil.

4. Keep the Ion OneTouch™ 2 Amplification Plate in the heat block.
5. Firmly insert the 3 ports of a new *single-use* Cleaning Adapter into the three holes on the top stage of the Ion OneTouch™ 2 Instrument (see the following illustration). The tab protruding from the outer edge of the Cleaning Adapter fits into the front notch of the stage:

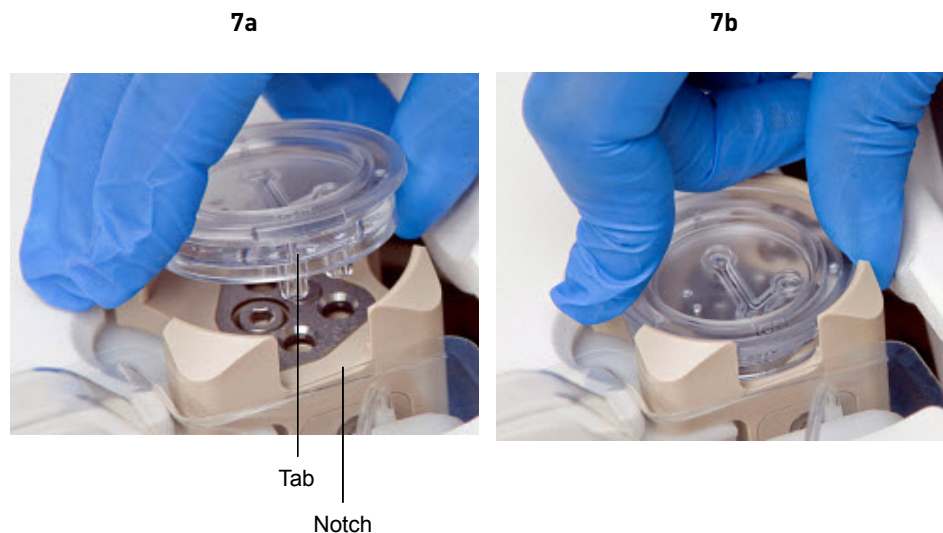

6. **Note:** Steps 6–9 are only necessary if you have not already removed the disposable injector before removing the Recovery Tubes from the instrument. Place a 50-mL conical tube in a tube rack, then place the tube rack with the tube adjacent to the instrument.
  7. Gently pull the disposable tubing downwards on the both sides of the pinch valve until the disposable tubing is out of the valve.
  8. Remove the disposable injector from the Ion OneTouch™ DL Injector Hub:
    - a. Place one hand on the centrifuge lid.
    - b. With the other hand, firmly grip the rigid plastic connector at the top of the disposable injector.
    - c. Slowly and steadily withdraw the disposable injector straight from the port of the Injector Hub:
- 
-  **CAUTION! PHYSICAL INJURY HAZARD.** The pointed end of the disposable injector can puncture your skin. Keep your hand away from the point of the disposable injector.
- 
9. Place the used, disposable injector into the empty 50-mL conical tube in the tube rack. The conical tube is used to collect waste.

10. On the home screen of the instrument, touch **Clean**:

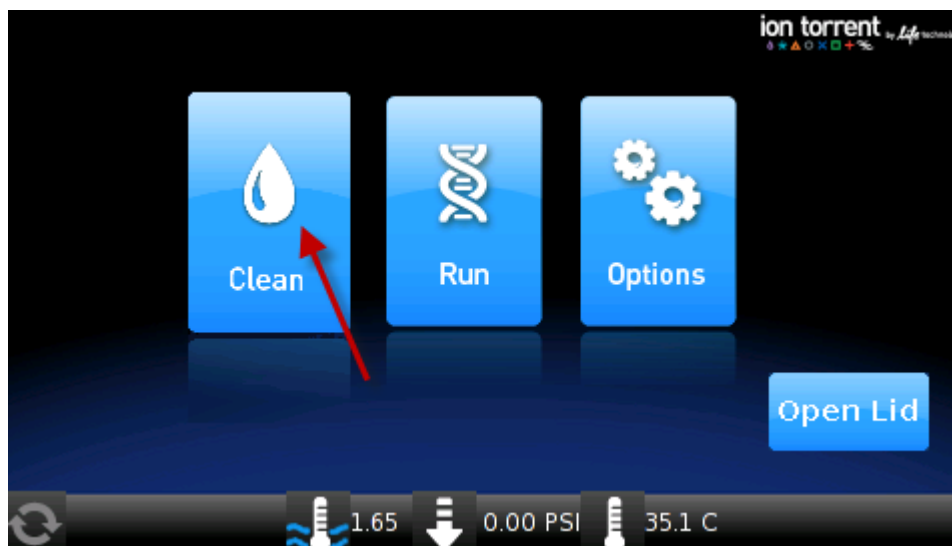

11. Complete each task displayed on the screen, then touch **Next**. After you touch **Next** on the last task, a progress bar appears, and the cleaning begins.
12. At the end of the cleaning run, the screen displays "**Time Remaining 00:00:00, Cleaning Run Complete**". Press **Next**, then ensure that the task in bold displays: "**Remove plate, injector, conical tube, and waste**".
- Note:** Keep the used Cleaning Adapter on the instrument between runs.
13. Appropriately dispose of the waste in the 50-mL conical tube.
14. Remove and appropriately dispose of the used Amplification Plate, disposable injector, and tubing:
- Push the handle to open the heat block.
  - Remove the disposable tubing from the Ion OneTouch™ DL Catch.
  - Gently pull back the Amplification Plate from the inlet and outlet holes of the instrument.
  - Remove the Amplification Plate from the heat block, then appropriately dispose of the used Amplification Plate, injector, and tubing.
  - Leave the heat block open.



**CAUTION! Hot Surface.** Use care when working around this area to avoid being burned by hot components.

15. On the instrument display, touch **Open Lid**, wait until the lid clicks open, then open the centrifuge lid. Wipe the residue from the centrifuge lid with dry Kimwipes™ disposable wipers and close the centrifuge lid.
16. Touch **Next** to return to the home screen on the instrument.





# Enrich the template-positive Ion PGM™ Template OT2 200 ISPs

■ Materials required .....	41
■ Perform the residual volume test on the Ion OneTouch™ ES .....	42
■ Prepare reagents then fill the 8-well strip .....	42
■ Prepare the Ion OneTouch™ ES .....	45
■ Perform the run .....	47
■ Perform Ion Sphere™ Particles quality control .....	49

## Materials required

### Provided in Ion PGM™ Template OT2 Solutions 200 Kit (Part no. 4481105):

- Ion OneTouch™ Wash Solution
- MyOne™ Beads Wash Solution
- Tween™ Solution
- Neutralization Solution
- Nuclease-free Water

### Provided in Ion PGM™ Template OT2 Supplies 200 Kit (Part no. 4480981):

- 8-well strip
- Eppendorf™ LoRetention Dualfilter Tips (P300)

### Other Materials and Equipment:

- Ion PGM™ Enrichment Beads (Cat. no. 4478525; Dynabeads™ MyOne™ Streptavidin C1 Beads)
- 1.5-mL Eppendorf LoBind™ Tubes
- 0.2-mL PCR tubes
- 1 M NaOH
- Pipettes
- Vortexer
- DynaMag™ -2 magnet
- Microcentrifuge

## Perform the residual volume test on the Ion OneTouch™ ES

**IMPORTANT!** Ensure that the AC line voltage module is installed correctly into the Ion OneTouch™ ES Instrument. Refer to the *Unpack and Install the Ion OneTouch™ 2 System Product Insert* (Pub. no. 4481875).

Ensure that the Ion OneTouch™ ES is set up (see “Set up the Ion OneTouch™ ES” on page 79).

If the condition is...	Then...
First use of the instrument and during monthly maintenance	Perform a residual volume test (see “Perform a residual volume test” on page 83).
Routine use and residual volume in Well 1 and Well 8 is >5.0 µL	
Routine use and residual volume in Well 1 and Well 8 is ≤5.0 µL	Operate the instrument without performing the residual volume test. Proceed to “Prepare reagents then fill the 8-well strip” on page 42.

## Prepare reagents then fill the 8-well strip

### Prepare Melt-Off Solution

Prepare fresh Melt-Off Solution by combining the components in the following order:

Order	Component	Volume
1	Tween™ Solution	280 µL
2	1 M NaOH	40 µL
—	<b>Total</b>	<b>320 µL</b>

**IMPORTANT!** Prepare Melt-Off Solution as needed, but appropriately dispose of the solution after 1 day.

The final composition of the Melt-Off Solution is 125 mM NaOH and 0.1% Tween™ 20 detergent.

### Wash and resuspend the Dynabeads™ MyOne™ Streptavidin C1 Beads

1. Vortex the tube for 30 seconds to thoroughly resuspend the beads, then centrifuge the tube of Dynabeads™ MyOne™ Streptavidin C1 Beads for 2 seconds.
2. Open the tube, then use a new tip to pipet up and down the dark pellet of beads until the pellet disperses. *Immediately* proceed to the next step.
3. Transfer 13 µL of Dynabeads™ MyOne™ Streptavidin C1 Beads to a new 1.5-mL Eppendorf LoBind™ Tube.
4. Place the tube on a magnet such as a DynaMag™-2 magnet for 2 minutes, then *carefully* remove and discard the supernatant without disturbing the pellet of Dynabeads™ MyOne™ Streptavidin C1 Beads.

5. Add 130  $\mu\text{L}$  of MyOne™ Beads Wash Solution to the Dynabeads™ MyOne™ Streptavidin C1 Beads.

**Note:** You add the resuspended Dynabeads™ MyOne™ Streptavidin C1 Beads in the 130  $\mu\text{L}$  MyOne™ Beads Wash Solution to Well 2 of the 8-well strip.

6. Remove the tube from the magnet, vortex the tube for 30 seconds, and centrifuge the tube for 2 seconds.

### Fill the 8-well strip

1. Ensure that the template-positive ISPs from the Ion OneTouch™ 2 Instrument are in 100  $\mu\text{L}$  of Ion PGM™ OT2 Recovery Solution and are in Well 1 of the 8-well strip (see “Recover the template-positive ISPs” on page 35). Well 1 with the ISPs is on the *left*:

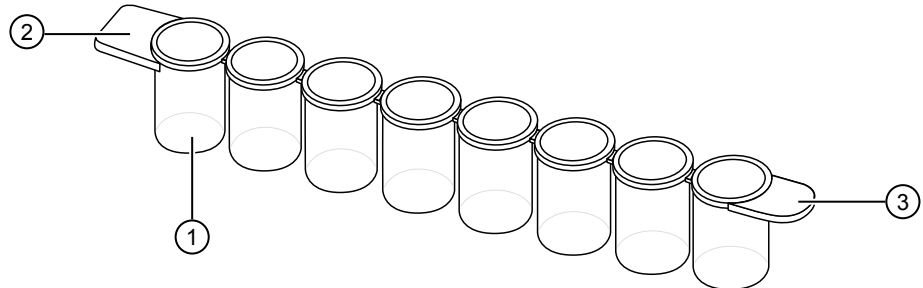

- ① Well 1
- ② Square-shaped tab
- ③ Rounded tab

**Note:** If the template-positive ISPs were stored at 2°C to 8°C, centrifuge the ISPs at  $15,500 \times g$  for 2.5 minutes, then carefully remove all but 100  $\mu\text{L}$  of supernatant. With a new tip, pipet up and down to resuspend the ISPs. Transfer the suspension from the tube into Well 1 of the 8-well strip.

2. If you have not already assessed the quality of the unenriched, template-positive ISPs, use one of the following methods:

Quality assessment by...	Then...
Qubit™ 2.0 or Qubit™ 3.0 Fluorometer	Transfer a 2.0-μL aliquot of the unenriched to a 0.2-mL PCR Tube, then see “Quality control using the Qubit™ 2.0 Fluorometer” on page 57, or “Quality control using the Qubit™ 3.0 Fluorometer” on page 70.
(Optional) Guava™ easyCyte™ 5 Flow Cytometer	Transfer a 1.0 μL aliquot of the unenriched ISPs to a 1.5-mL Eppendorf LoBind™ Tube. Refer to the <i>Ion Sphere™ Particles (ISPs) Quality Assessment Using the Guava™ easyCyte™ 5 Flow Cytometer User Bulletin</i> (Pub. no. 4470082), available on the Ion Community website: <a href="http://ioncommunity.thermofisher.com">ioncommunity.thermofisher.com</a>
Demonstrated protocol: Quality assessment by the Applied Biosystems™ Attune™ Acoustic Focusing Cytometer	Transfer a 1.0-μL aliquot of the unenriched ISPs to a 1.5-mL microcentrifuge tube. Put the sample on ice, then refer to <i>Demonstrated Protocol: Ion Sphere™ Particles (ISPs) Quality Assessment using the Applied Biosystems™ Attune™ Acoustic Focusing Cytometer User Bulletin</i> (Pub. no. 4477181), available on the Ion Community website: <a href="http://ioncommunity.thermofisher.com">ioncommunity.thermofisher.com</a>

3. Fill the remaining wells in the 8-well strip as follows (see the figure following step 4):

Well number	Reagent to dispense in well
Well 1 <sup>[1]</sup>	Entire template-positive ISP sample [100 μL; prepared in step 1 of this procedure (U)]
Well 2	130 μL of Dynabeads™ MyOne™ Streptavidin C1 Beads resuspended in MyOne™ Beads Wash Solution ] prepared in “Wash and resuspend the Dynabeads™ MyOne™ Streptavidin C1 Beads” on page 42 (B)]
Well 3	300 μL of Ion OneTouch™ Wash Solution (W)
Well 4	300 μL of Ion OneTouch™ Wash Solution (W)
Well 5	300 μL of Ion OneTouch™ Wash Solution (W)
Well 6	Empty
Well 7	300 μL of freshly-prepared Melt-Off Solution [prepared in “Prepare Melt-Off Solution” on page 42 (M)]
Well 8	Empty

<sup>[1]</sup> Well closest to the square-shaped tab

4. Confirm that the square-shaped tab is on the left, then insert the filled 8-well strip with the 8-well strip pushed all the way to the right end of the slot of the Tray:

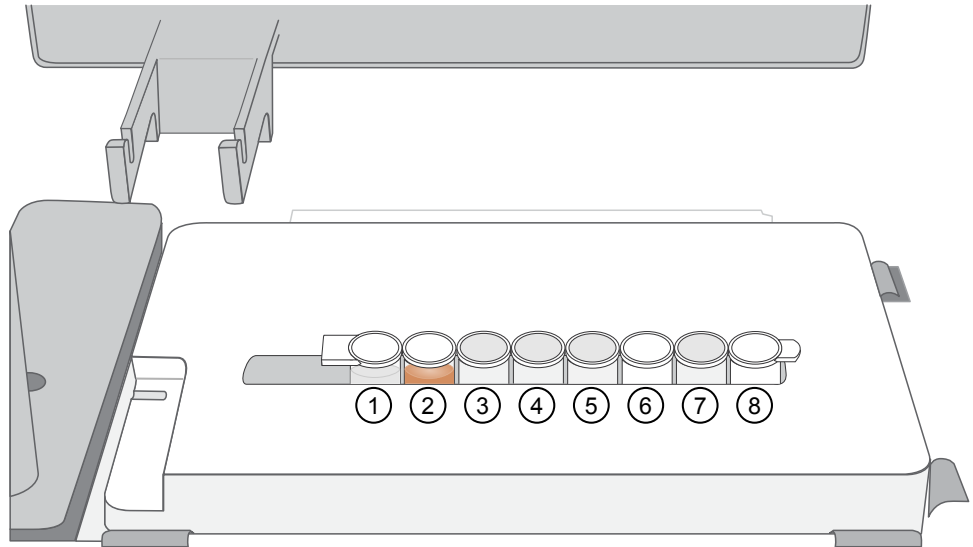

## Prepare the Ion OneTouch™ ES

1. Load a new tip in the Tip Arm:
  - a. Place a new tip in the Tip Loader: Remove the Tip Arm from the cradle and align the metal fitting of the Tip Arm with the tip. Keeping the fitting on the Tip Arm vertical, firmly press the Tip Arm down onto the new tip until the Tip Arm meets the Tip Loader. Hold the Tip Arm to the Tip Loader for ~1 second to ensure proper installation of the tip. Lift the Tip Arm straight up to pull the installed tip from the Tip Loader tube:

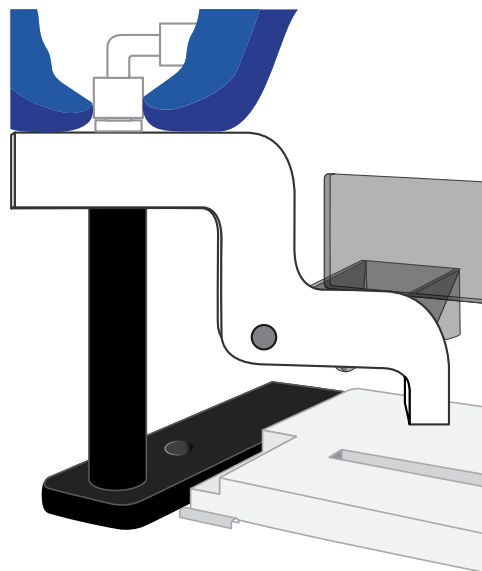

- b. Return the Tip Arm to the cradle: Tilt the Tip Arm back (see Figure b1). Align the pins with the round notches in the cradle (see Figure b2), then lower the Tip Arm into position (see Figure b3). Move the Tip Arm forward into the working position:

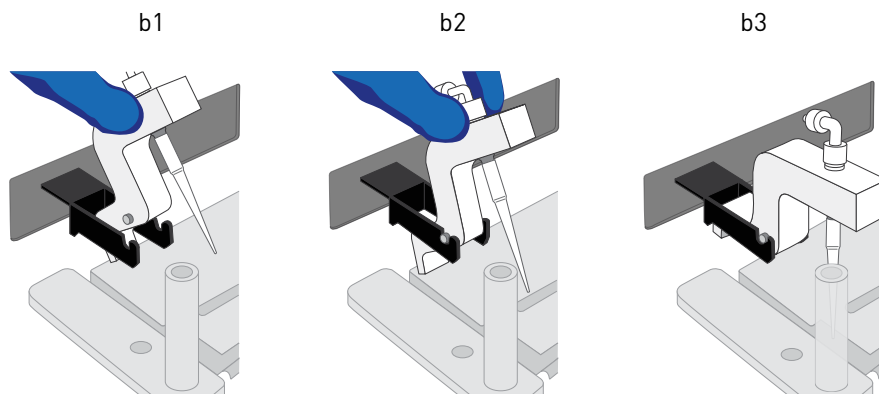

2. Ensure that the back/bottom end of the Tip Arm is not resting on top of the thumb screw, causing the Tip Arm to tilt forward. This is the correct position of the Tip Arm:

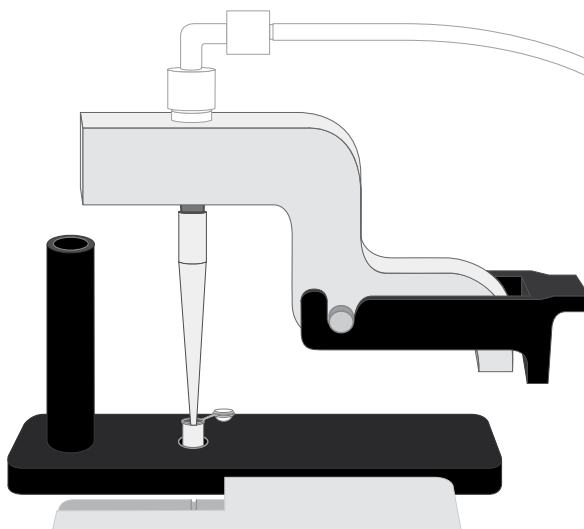

3. Add 10  $\mu$ L of Neutralization Solution to a new 0.2-mL PCR tube.
4. Insert the opened 0.2-mL PCR tube with the Neutralization Solution into the hole in the base of the Tip Loader, as shown in the preceding figure.

## Perform the run

1. *Confirm that a new tip and opened 0.2-mL PCR tube with the Neutralization Solution have been loaded* and that the 8-well strip is correctly loaded. Ensure that Well 1 (ISP sample) is the left-most well and that the 8-well strip is pushed to the far-right position within the slot.
2. Pipet the contents of Well 2 up and down to resuspend the beads before starting the run. Do not introduce bubbles into the solution.
3. If necessary, turn ON the Ion OneTouch™ ES and wait for the instrument to initialize. The screen displays “rdy”. The Tip Arm performs a series of initialization movements and returns to the home position (~5 seconds).
4. Press **Start/Stop**. The screen displays “run” during the run. The run takes ~35 minutes.

**Note:** If necessary to stop a run, press **Start/Stop**. The instrument completes the current step, then stops the run and displays “End”. Press **Start/Stop** again to return the Tip Arm to the home position. It is not possible to restart (where you left off) after stopping a run.

5. At the end of the run, the instrument displays “End” and beeps every 60 seconds. Press the **Start/Stop** button to silence this alarm and reset the Ion OneTouch™ ES for the next run. The instrument can be left on between runs.
6. *Immediately after the run*, securely close and remove the PCR tube containing the enriched ISPs.
7. Mix the contents of the PCR tube by gently inverting the tube 5 times.

**Note:** Ensure that the 0.2-mL PCR tube has >200 µL of solution containing the enriched ISPs. After a successful run on the instrument, the sample is in ~230 µL of Melt-Off Solution, Ion OneTouch™ Wash Solution, and Neutralization Solution. If the tube has <<200 µL of solution containing the enriched ISPs, contact Technical Support.

8. Remove the used tip: While you are standing above the Tip Arm, and with the Tip Arm in its cradle, twist the tip *counterclockwise* and pull it downward to remove and discard the tip:

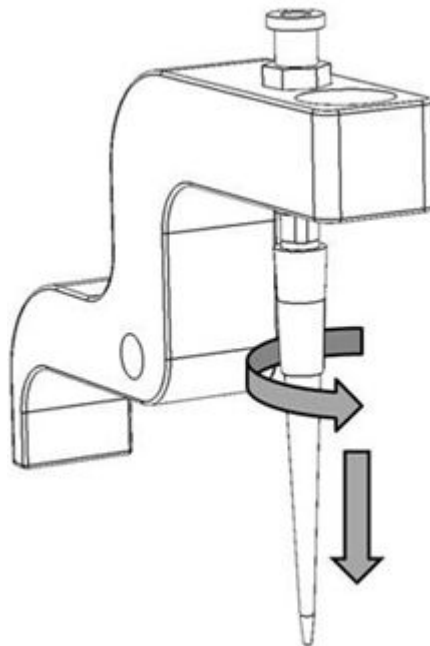

---

**IMPORTANT!** Improper removal of tips can loosen the metal tip adapter fitting on the Tip Arm and affect instrument operation.

---

9. Remove and discard the used 8-well strip.



## Perform Ion Sphere™ Particles quality control

Determine the enrichment efficiency using one of the following methods:

Quality assessment by...	Then...
Guava™ easyCyte™ 5 Flow Cytometer	Transfer a 1.0-µL aliquot of the enriched ISPs to a 1.5-mL Eppendorf LoBind™ Tube. Refer to the <i>Ion Sphere™ Particles (ISPs) Quality Assessment Using the Guava™ easyCyte™ 5 Flow Cytometer User Bulletin</i> (Pub. no. 4470082), available on the Ion Community website: <b>ioncommunity.thermofisher.com</b>
Demonstrated protocol: Quality assessment by the Applied Biosystems™ Attune™ Acoustic Focusing Cytometer	Transfer a 1.0-µL aliquot of the enriched ISPs to a 1.5-mL Eppendorf LoBind™ Tube. Put the sample on ice, then refer to <i>Demonstrated Protocol: Ion Sphere™ Particles (ISPs) Quality Assessment using the Applied Biosystems™ Attune™ Acoustic Focusing Cytometer User Bulletin</i> (Pub. no. 4477181), available on the Ion Community website: <b>ioncommunity.thermofisher.com</b>



# Troubleshooting

## Ion OneTouch™ 2 Instrument

Observation	Possible cause	Recommended action
Firmware does not update or the status update screen does not display ≤10 seconds	Firmware not updating on the instrument	<ol style="list-style-type: none"><li>1. Power the instrument OFF then ON.</li><li>2. Ensure that the USB flash drive is FAT32-formatted and that the file is in the root directory.</li><li>3. Remove then reinsert the USB flash drive immediately after the main menu displays.</li><li>4. Repeat steps 1–3 as needed.</li></ol>
Disposable injector remains in "down" position in the Ion OneTouch™ DL Injector Hub	<ul style="list-style-type: none"><li>• Reagent build-up</li><li>• New part</li></ul>	<ol style="list-style-type: none"><li>1. <i>Gently</i> pull from the top of the disposable injector until the disposable injector just returns to the "up" position in the Injector Hub (see "Install the disposable injector" on page 105).</li><li>2. Briefly press then release the spring-loaded top of the Injector Hub 5-10 times at the point indicated by the arrow (see illustration in "Install the disposable injector" on page 105). You should hear a click.</li><li>3. If the Injector Hub remains in the "down" position, repeat step 2 once (up to 10 more clicks).</li></ol> <p><b>Note:</b> If the Injector Hub still does not move freely and click up into place, then contact Technical Support.</p>

Observation	Possible cause	Recommended action
Centrifuge lid does not open	<ul style="list-style-type: none"> <li>• Power failure</li> <li>• Software crash</li> </ul>	<ol style="list-style-type: none"> <li>1. Slide a 1/8-inch L-wrench (hex wrench) or equivalent tool into the right hole and along the top edge of the centrifuge hinge:               <div data-bbox="971 384 1479 684" style="text-align: center;">  </div> </li> <li>2. Push the tool into the hole until there is a slight compression of the tool against the instrument and the centrifuge lid unlocks and opens.</li> <li>3. Remove the tool from the hole, then open the lid.</li> <li>4. If necessary, troubleshoot the lid lock, then use the instrument normally. Do <i>not</i> force the lid open.</li> </ol>
Run fails	Various	<p>Retrieve the log files.</p> <p><b>IMPORTANT!</b> Do <i>not</i> turn off or power cycle the instrument until the log files are downloaded. If a run fails, contact Technical Support.</p>
Precipitate in the Ion PGM™ Template OT2 200 Reagent Mix after vortexing	Storage of thawed Reagent Mix <2°C	<ol style="list-style-type: none"> <li>1. Ensure that the solution is fully thawed.</li> <li>2. Vortex the solution for 30 seconds, then leave the tube at room temperature for 15 minutes.</li> <li>3. Vortex the solution again at maximum speed for 1 minute.</li> <li>4. Centrifuge the tube for 30 seconds.</li> <li>5. Visually inspect the solution at the bottom of the tube and verify that there is no residual precipitate. If precipitate is visible, then repeat steps 1–4.</li> </ol> <p><b>Note:</b> If precipitate is still visible, then contact Technical Support.</p> <ol style="list-style-type: none"> <li>6. Keep the Reagent Mix at room temperature during use.</li> <li>7. After use, store the solution at 2°C to 8°C.</li> </ol>
Excessive oil in the waste tray	Various	<ol style="list-style-type: none"> <li>1. Remove the oil waste tray, then appropriately dispose of the oil.</li> <li>2. Reinsert the tray into the slot, then push the tray back fully into the instrument.</li> <li>3. To further troubleshoot excessive oil from the instrument, contact Technical Support.</li> </ol>



## Ion OneTouch™ ES

Observation	Possible cause	Recommended action
Excessive foaming	<ul style="list-style-type: none"><li>• Improperly calibrated or inadequate volume in one or more wells</li><li>• Loose fitting</li><li>• Cracked pipette tip</li></ul>	<ol style="list-style-type: none"><li>1. Use the recommended volumes for all wells.</li><li>2. Ensure that fittings are tight, especially at the elbow fitting, and the pipette tip is not cracked.</li><li>3. If necessary, perform the residual volume check. If the residual volume check fails, then calibrate the instrument.</li></ol>
Brown pellet in centrifuged tube of enriched ISPs	Residual Dynabeads™ MyOne™ Streptavidin C1 Beads	<ol style="list-style-type: none"><li>1. Pipet the suspension with the brown pellet up and down 10 times to resuspend the pellet.</li><li>2. Place the 0.2-mL PCR tube against a magnet such as a DynaMag™-2 magnet for 4 minutes.</li><li>3. Transfer the supernatant with the enriched ISPs to a new 0.2-mL PCR tube without disturbing the pellet of Dynabeads™ MyOne™ Streptavidin C1 Beads.</li><li>4. Sequence or store the enriched ISPs.</li></ol>

Observation	Possible cause	Recommended action
<p>E12, E22, or E23 error displays during the run or during calibration</p>	<p>Calibration values are out of range</p>	<ol style="list-style-type: none"> <li>1. Power OFF the instrument. and wait 3 seconds.</li> <li>2. While holding down <b>Vert. Adjust</b>, power ON the instrument. This step restores the factory default settings.</li> <li>3. Recalibrate the vertical axis (see “Vertical axis calibration” on page 87):                             <p><b>Note:</b> The default setting for the vertical axis is 310. If the setting is &lt;310, the instrument will likely display an error, because the Tip Arm position is too high.</p> <ol style="list-style-type: none"> <li>a. Press the ▼ (minus) button to lower the Tip Arm until the tip touches the shelf.</li> <li>b. Press the ▼ (minus) button 8 more times. Typical vertical axis settings are ~340–370.</li> </ol> </li> <li>4. Recalibrate the horizontal axis (see “Horizontal axis calibration” on page 89): Press the ▲ (plus) button to move the Tip Arm to the right until the tip touches the left tab of the strip.                             <p><b>Note:</b> The default setting for the horizontal axis is 625. Typical horizontal axis settings are ~640–670.</p> </li> </ol>
	<p>AC line voltage module installed incorrectly</p>	<ol style="list-style-type: none"> <li>1. Determine the voltage of the electrical outlet to plug in the Ion OneTouch™ ES.</li> <li>2. Align the arrow by the correct voltage on the AC line voltage module with the adjacent white arrow in the lower-right corner of the fuse socket.</li> </ol> <p>If the AC line voltage module is installed incorrectly:</p> <ol style="list-style-type: none"> <li>1. Gently remove the module with your fingernail or a small flathead screwdriver.</li> <li>2. Rotate the module so that the correct voltage on the module is aligned and adjacent to the white arrow in the lower right-hand corner of the fuse socket.</li> <li>3. Insert the AC line voltage module into the fuse socket.</li> </ol>



Observation	Possible cause	Recommended action
E12 or E22 error displays when the unit is initializing	<ul style="list-style-type: none"> <li>• Fuse installed incorrectly</li> <li>• Unit below operating temp</li> <li>• Bad program or calibration setting <i>or</i></li> <li>• Tip Arm is not moving</li> </ul>	<ol style="list-style-type: none"> <li>1. Ensure that the fuse module is installed correctly and that the unit is at its recommended operating temperature.</li> <li>2. Reboot the instrument: Power OFF the instrument, wait 3 seconds, then power ON the instrument.</li> <li>3. If the error persists, restore the factory defaults, then re-calibrate the instrument:               <ol style="list-style-type: none"> <li>a. Power OFF the instrument and wait 3 seconds.</li> <li>b. While holding down <b>Vert. Adjust</b>, power ON the instrument. This step restores the factory default settings.</li> <li>c. Repeat 3a–3b as needed to restore the factory defaults.</li> <li>d. Calibrate the vertical and horizontal axes (see “Vertical axis calibration” on page 87 and “Horizontal axis calibration” on page 89).</li> </ol> </li> </ol>
Either of the following: <ul style="list-style-type: none"> <li>• E12 or E22 error displays</li> <li>• Tip Arm does not move or moves slightly</li> </ul>	AC line voltage module installed incorrectly	<ol style="list-style-type: none"> <li>1. Determine the voltage of the electrical outlet to plug in the Ion OneTouch™ ES.</li> <li>2. Align the arrow by the correct voltage on the AC line voltage module with the adjacent white arrow in the lower-right corner of the fuse socket.</li> </ol> <p>If the AC line voltage module is installed incorrectly:</p> <ol style="list-style-type: none"> <li>1. Gently remove the module with your fingernail or a small flathead screwdriver.</li> <li>2. Rotate the module so that the correct voltage on the module is aligned and adjacent to the white arrow in the lower right-hand corner of the fuse socket.</li> <li>3. Insert the AC line voltage module into the fuse socket.</li> </ol>
	Instrument is not at the recommended operating temperature	Ensure that the Ion OneTouch™ ES is at an operating temperature of 60°F to 77°F (15°C to 25°C).
Solution overflowing during run	Overloaded reagent volumes	Repeat with reagent volumes described in enrichment procedure.
Tip is causing 8-well strip to lift out of Tray slot during run	Tip is not aligned vertically	Perform vertical calibration procedure (see “Vertical axis calibration” on page 87).
Percent template-positive ISPs after enrichment is <50% as measured by flow cytometry	Multiple causes	Contact Technical Support.



Observation	Possible cause	Recommended action
One of the following: <ul style="list-style-type: none"> <li>• Strip lifts up during strip push</li> <li>• Strip lifts up when tip is raised from well</li> <li>• Immediately after strip push, the strip is not in contact with the magnet</li> </ul>	Instrument is not calibrated properly	<ul style="list-style-type: none"> <li>• Perform horizontal position calibration (see “Vertical axis calibration” on page 87).</li> <li>• Perform vertical calibration (see “Horizontal axis calibration” on page 89).</li> <li>• Perform horizontal position calibration (see page “Vertical axis calibration” on page 87).</li> </ul>
Tip grinds into base of instrument and Code “1999” displays	<ul style="list-style-type: none"> <li>• Unit not calibrated properly</li> <li>• Vertical calibration setting too low or out-of-range</li> </ul>	<ol style="list-style-type: none"> <li>1. Erase the memory on the instrument: Hold down the vertical adjust button while powering ON the instrument. The instrument beeps several times.</li> <li>2. Recalibrate the instrument (see “Calibrate the Ion OneTouch™ ES Instrument” on page 87).</li> <li>3. Perform a residual volume test (see “Perform a residual volume test” on page 83).</li> </ol>
Tip is hitting the top of tray at start of run	Tray is not properly seated in the instrument	Check for debris between the tray and the instrument, then reinstall the tray. Press down firmly to ensure that tray is fully seated in the instrument.
Error displays	Various	<ol style="list-style-type: none"> <li>1. Power the instrument OFF then ON.</li> <li>2. If the error continues to display, erase the memory on the instrument. Hold down the vertical adjust button while powering ON the instrument. The instrument beeps several times.</li> <li>3. Recalibrate the instrument (see “Calibrate the Ion OneTouch™ ES Instrument” on page 87).</li> <li>4. Perform residual volume check (see “Perform a residual volume test” on page 83).</li> </ol>
Instrument does not aspirate or dispense liquids	Loose fitting(s)	<ul style="list-style-type: none"> <li>• Ensure that the Luer-Lok™ connections at the elbow on the Tip Arm and at the tubing on the rear syringe pump are finger-tight.</li> <li>• Ensure that the metal tip adapter fitting on the Tip Arm is finger-tight.</li> </ul> <p><b>IMPORTANT!</b> After any adjustments to the metal tip adapter, recalibrate the Ion OneTouch™ ES.</p>



# Quality control of Ion PGM™ Template OT2 200 ISPs

- Quality Control assay ..... 56
- Quality control using the Qubit™ 2.0 Fluorometer ..... 57
- Quality control using the Qubit™ 3.0 Fluorometer ..... 70
- Acceptance criteria for unenriched Ion PGM™ Template OT2 200 Ion Sphere™ Particles ..... 76
- ISP Quality Control assay troubleshooting table ..... 77
- Quality control using the Guava™ easyCyte™ 5 Flow Cytometer ..... 77
- Quality control using the Attune™ Acoustic Focusing Cytometer ..... 78

## Quality Control assay

The Ion Sphere™ Quality Control assay on the Qubit™ 2.0 or Qubit™ 3.0 Fluorometer measures the fluorescence of template-positive Ion Sphere™ Particles (ISPs) labeled with two fluorophores: Alexa Fluor™ 488 and Alexa Fluor™ 647.

- A probe labeled with Alexa Fluor™ 488 anneals to primer B sites, or all of the ISPs present.
- A probe labeled with Alexa Fluor™ 647 anneals to primer A sites, or only the ISPs with extended templates.

The ratio of the Alexa Fluor™ 647 fluorescence (templated ISPs) to the Alexa Fluor™ 488 fluorescence (all ISPs present) yields the % templated ISPs.

The following schematic shows Alexa Fluor™ 488- and Alexa Fluor™ 647-labeled probes annealed to an ISP:

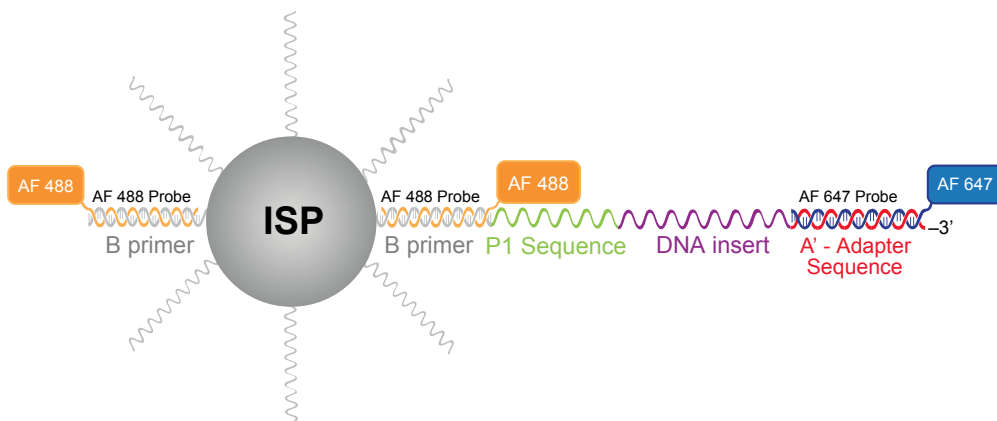



## Quality control using the Qubit™ 2.0 Fluorometer

---

**IMPORTANT!** Effective 15 February 2012, the Alexa Fluor™ 488 and Alexa Fluor™ 647 Calibration Standards replace the spectrally similar FAM™ and Cy®5 dyes, respectively, previously used in the kit. To update the existing plugin on the Qubit™ 2.0 Fluorometer with the new dye names, install the new plugin file, Ion\_PluginV310\_AF.qbt.

---

Both sets of dye-labeled calibration standards can be used in conjunction with firmware version 3.00 and previous versions of plugin files (ion\_plugin.qbt or Ion\_plugin\_AF.qbt).

We highly recommend that you install the new firmware version 3.10 and the new Ion plugin file (Ion\_PluginV310\_AF) for ease of use as these new versions allow you to operate the Ion plugin on the Qubit™ 2.0 Fluorometer without requiring the USB drive Log to be connected into the device at all times.

The selection options on the user interface of the instrument matches the new Alexa Fluor™ 488 and Alexa Fluor™ 647 Calibration Standards once the new plugin file is installed.

### Materials required

- Qubit™ 2.0 Fluorometer with the V3.10 firmware and the Ion Sphere™ Quality Control assay
- Qubit™ Assay Tubes (Cat. no. Q32856)
- PCR tubes, 0.2 mL (Axygen Cat. no. PCR-02-L-C or BioExpress Cat. no. T-3035-1)
- Qubit™ Easy Calculator Microsoft™ Excel™ Spreadsheet file containing the instrument specific Calibration Factor
- Ion Sphere™ Quality Control Kit (Cat. no. 4468656)
- Unenriched Ion Sphere™ Particles
- GeneAmp™ PCR System 9700 thermal cycler (Cat. no. N8050200) or equivalent

## Upgrade the Qubit™ 2.0 Fluorometer firmware and software

This section provides information about upgrading the firmware and the software of the Qubit™ 2.0 Fluorometer. The following illustration summarizes the upgrade path for each firmware version.

### Qubit™ 2.0 Fluorometer Firmware v2.00 or v3.00

To a USB drive, download the program and upgrade files (Ion\_PluginV310\_AF.qbt, V3.10 Qubit\_FW\_MainCPU.bin, and V3.10 Qubit\_FW\_UsbHost.bin).



Power on the Qubit™ 2.0 Fluorometer and connect the USB drive.



Touch **V2.00** or **V3.00**.



Touch **Update**.



When prompted, touch **Yes** to upload the Ion Sphere™ Quality Control Assay for V3.10.

### Qubit™ 2.0 Fluorometer Firmware v3.10

To a USB drive, download the program file (Ion\_PluginV310\_AF.qbt).



Power on the Qubit™ 2.0 Fluorometer and connect the USB drive.



When prompted, touch **Yes** to upload the Ion Sphere™ Quality Control Assay for V3.10.

## Upgrade for firmware V2.00 or V3.00

**Note:** The previous program files (.qbt) are not compatible with the new V3.10 firmware. The new program file (Ion\_PluginV310\_AF.qbt) is not compatible with V3.00 firmware.

### Materials required for update

- Qubit™ 2.0 Fluorometer
- USB drive (included with Qubit™ 2.0 Fluorometer)
- Program (.qbt) and upgrade (.bin) files:
  - Ion\_PluginV310\_AF.qbt
  - V3.10 Qubit\_FW\_MainCPU.bin
  - V3.10 Qubit\_FW\_UsbHost.bin

## Download update files

We recommend that you use a Windows™ OS-based computer to download and transfer the Qubit™ 2.0 Fluorometer files to the USB drive.

**Note:** Do not use a Macintosh™ computer to transfer the files to the USB drive if the serial number of your Qubit™ 2.0 Fluorometer is lower than 1104004846.

We also recommend that you use the USB drive provided with Qubit™ 2.0 Fluorometer for file transfer.

Other compatible USB drives may also be used. Visit: <http://ioncommunity.thermofisher.com/community/products/pgm/> to see a list of approved USB drives. Logging into the Ion Community is required.

1. Download the program file (.qbt) and two upgrade files (.bin) from <http://ioncommunity.thermofisher.com/community/products/pgm/> onto a Windows™-based PC desktop. Logging into the Ion Community is required.
2. Remove the existing program file (.qbt) and two upgrade files (.bin) from the USB drive, if any.
3. Transfer the three downloaded files to the USB drive provided with the Qubit™ 2.0 Fluorometer (recommended), or another compatible USB drive.

**Note:** Files on the USB drive must be in the root directory and cannot be in a folder.

## Upgrade the firmware

1. Power on the Qubit™ 2.0 Fluorometer by plugging in the unit.
2. Insert the USB drive, containing the program (.qbt) and upgrade (.bin) files, into the USB port on the instrument.
3. In the upper-right corner of the main menu, touch **V2.00**, or **V3.00** depending on the version.
4. If the image of the USB drive in the update screen displays a green dot, touch Update to upgrade the instrument firmware.

The firmware update lasts approximately 2 minutes, during which the Qubit™ 2.0 Fluorometer screen flashes:

**Note:** If the image displays a red dot, the Qubit™ 2.0 Fluorometer cannot detect the USB drive. Ensure the USB drive is in place securely. If the problem persists, remove the USB drive and reinsert.

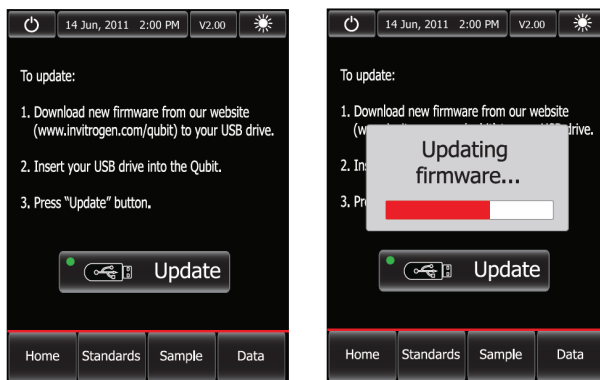

5. When the Qubit™ 2.0 Fluorometer displays the main screen, confirm that V3.10 is displayed (in the upper-right corner), which confirms that the upgrade was successful.

After the firmware has been updated, the following screen will be displayed. Confirm that V3.10 is displayed in the upper-right corner. Touch **Yes** to permanently upload the Ion Sphere™ QC program to the instrument:

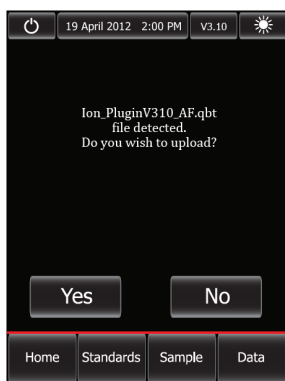

6. Confirm the Ion Sphere™ QC program (.qbt) file is functional by checking the following screens.
  - a. In the main menu, the Ion selection option is present:

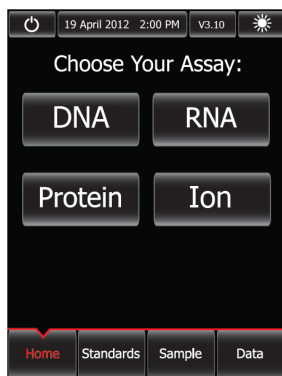

- b. After touching Ion ( Ion ), AF 488 ( AF 488 ) and AF 647 ( AF 647 ) selection options appear on the screen:

**Note:** Touching AF 488 or AF 647 enters the respective measurement channels.

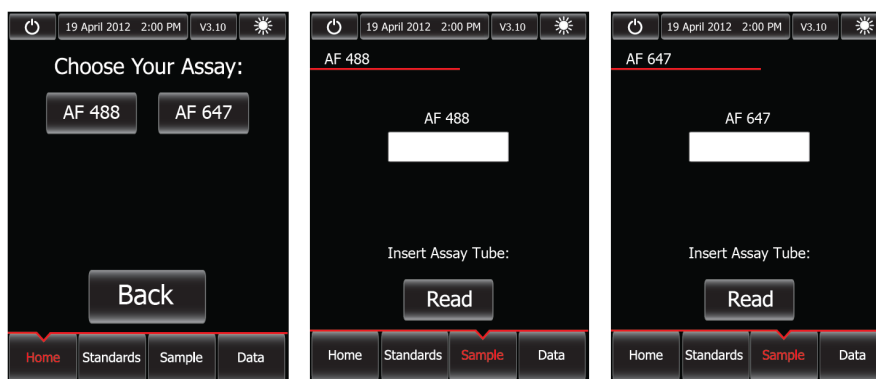

7. Proceed to complete the instruction in “Calculate the Qubit™ 2.0 Fluorometer Calibration Factor” on page 63.

### Upgrade for firmware V3.10

If your Qubit™ 2.0 Fluorometer is equipped with V3.10 firmware, you *only* need to upload the Ion Sphere™ Quality Control assay into your fluorometer:



Firmware version

---

**IMPORTANT!** Do not re-upgrade the firmware if the instrument is shipped with V3.10 version.

---

To upload the Ion Sphere™ Quality Control assay into your fluorometer, use the following steps:

1. Download the new Ion\_PluginV310\_AF.qbt file (from:<http://ioncommunity.thermofisher.com/community/products/pgm>) to your USB drive to activate the application to accept the new names. Logging into the Ion Community is required.

**Note:** We recommend that you use the USB drive provided with Qubit™ 2.0 Fluorometer for file transfer; however, other compatible USB drives may also be used. Visit:<http://ioncommunity.thermofisher.com/community/products/pgm> to see a list of approved USB drives. Logging into the Ion Community is required.

2. With the USB drive (containing the Ion\_PluginV310\_AF.qbt file) inserted into the Qubit™ 2.0 Fluorometer, power-cycle the instrument by unplugging and plugging it back in. Touch **Yes** to permanently upload the file to the instrument:

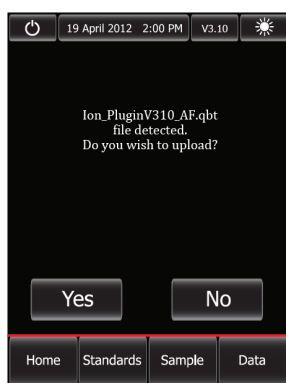

3. Confirm the Ion Sphere™ QC program (.qbt) file is functional by checking the following screens:
  - a. In the main menu, the Ion selection option is present.

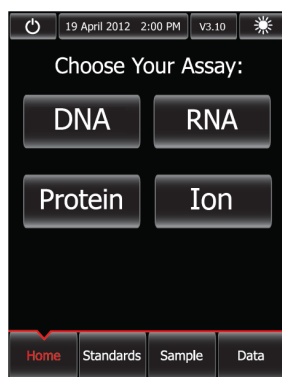

- b. After touching **Ion** (Ion), **AF 488** (AF 488) and **AF 647** (AF 647) selection options appear on the screen:

**Note:** Touching AF 488 or AF 647 enters the respective measurement channels.

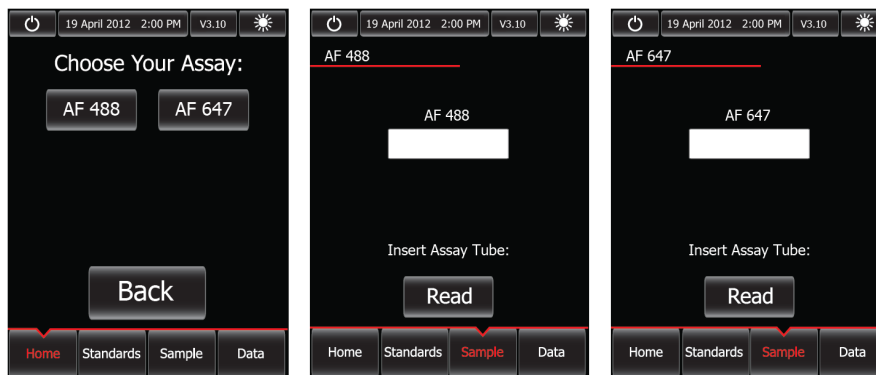

4. Proceed to “Calculate the Qubit™ 2.0 Fluorometer Calibration Factor”.

## Calculate the Qubit™ 2.0 Fluorometer Calibration Factor

This section describes the procedure to determine the Qubit™ 2.0 Fluorometer instrument-specific Calibration Factor.

---

**IMPORTANT!** You must upgrade the Qubit™ 2.0 Fluorometer firmware and software prior to performing the following procedure. See “Upgrade the Qubit™ 2.0 Fluorometer firmware and software” on page 58 for more information.

---

Each Qubit™ 2.0 Fluorometer has a unique Calibration Factor that must be calculated and applied to all Percent Templated ISPs calculations.

**Note:** It is only necessary to calculate the Calibration Factor once for a particular instrument, unless a problem is suspected.

### Materials required

- Qubit™ Easy Calculator Microsoft™ Excel™ Spreadsheet (Logging into the Ion Community is required.)
- Qubit™ 2.0 Fluorometer with V3.10 firmware
- USB drive containing the “.qbt” file
- Qubit™ Assay Tubes (Part no. Q32856)
- Ion Sphere™ Quality Control Kit (Cat. no. 4468656)

### Download the Qubit™ Easy Calculator

Download the Qubit™ Easy Calculator Microsoft™ Excel™ Spreadsheet file from: <http://ioncommunity.thermofisher.com/community/products/pgm/> (Logging into the Ion Community is required), and save the file to the computer used for Qubit™ 2.0 Fluorometer data analysis.

### Prepare the calibration standard

1. From the Ion Sphere™ Quality Control Kit, thaw the Alexa Fluor™ 488 and Alexa Fluor™ 647 Calibration Standard reagents.

**Note:** Both the Alexa Fluor™ 488 and Alexa Fluor™ 647 molecules are photosensitive, so avoid exposure to light for long periods of time and direct sunlight.

2. Vortex well to mix and pulse-spin the tube to remove any liquid trapped in the cap.
3. Transfer 200 µL of each standard into two separate Qubit™ assay tubes. Pulse-spin to bring all the liquid to the bottom of the tube.

### Measure the calibration standard

---

**IMPORTANT!** Prior to using the Qubit™ 2.0 Fluorometer, ensure that the instrument is running Firmware V3.10, and the Ion\_PluginV310\_AF.qbt file has been permanently uploaded to the instrument. See section “Upgrade the Qubit™ 2.0 Fluorometer firmware and software” on page 58 for more information about managing Qubit™ 2.0 Fluorometer firmware versions.

---

1. Touch **Ion** to access Alexa Fluor™ 488 and Alexa Fluor™ 647 measurement options.
2. Touch **AF 488** and insert the Alexa Fluor™ 488 Calibration Standard reagent into the Qubit™ 2.0 Fluorometer, close the lid, and touch **Read**.

**Note:** The lettering on the Read  selection option changes from white to red when reading a sample. The lettering changes back to white when the reading of the sample is finished in approximately 5 seconds.

3. Record the RFU value and remove sample from Qubit™ 2.0 Fluorometer.
4. Touch **Home**, touch **Ion**, and then touch **AF 647**. Insert the Alexa Fluor™ 647 Calibration Standard into the Qubit™ 2.0 Fluorometer, close the lid, and touch **Read**.

**Note:** The lettering on the Read  selection option changes from white to red when reading a sample. The lettering changes back to white when the reading of the sample is finished in approximately 5 seconds.

5. Record the RFU value and remove sample from Qubit™ 2.0 Fluorometer.



### Calculate the Calibration Factor

1. In the Qubit™ Easy Calculator, enter each recorded RFU value in the appropriately labeled green cell to display the Calibration Factor specific for the Qubit™ 2.0 Fluorometer.
2. Save a copy of the Qubit™ Easy Calculator containing the Calibration Factor for use as a template for future Percent Templated ISPs calculations:

**Note:** Affix a sticker with the instrument-specific Calibration Factor to the Qubit™ 2.0 Fluorometer.

Qubit Calibration Factor Calculation						
Calibration Standard	RFU		Calibration Factor			
Alexa Fluor® 488 Calibration Standard			#DIV/0!			
Alexa Fluor® 647 Calibration Standard			#DIV/0!			
Percent Templated ISPs						
Sample ID	Raw RFU Value		Background RFU (Negative Control Tube)		Conversion Factor*	Percent Templated ISPs
	AF 488	AF 647	AF 488	AF 647		
						#DIV/0!
						#DIV/0!
						#DIV/0!
						#DIV/0!
* Conversion factor can be found on Ion Community website ( <a href="http://ioncommunity.thermofisher.com/docs/DOC-9093">http://ioncommunity.thermofisher.com/docs/DOC-9093</a> ) and is Template Kit lot-specific.						
Green Cells = Raw RFU values of FAM and Cy5 Calibration Standards supplied in the Ion Sphere Quality Control Kit						
Red Cells = Raw RFU values measured in "Measure the templated unenriched sample"						
Purple Cells = Raw RFU values measured for negative control in "Measure the templated unenriched sample"						
Blue Cells = Template kit lot specific conversion factor						

**IMPORTANT!** For each Qubit™ 2.0 Fluorometer used, save a separate Qubit™ Easy Calculator Microsoft™ Excel™ Spreadsheet file containing the Calibration Factor specifically calculated for that particular instrument.

### Measure the templated unenriched sample

This section describes the procedure for determining the percent templated ISPs for unenriched Ion Sphere™ Particles.

#### Prepare the sample

1. From the Ion Sphere™ Quality Control Kit, thaw the Ion Probes tube, Annealing Buffer, and Quality Control Wash Buffer.
2. For unenriched Ion PGM™ Template OT2 200 Ion Sphere™ Particles, if not 100 µL, adjust sample volume to 100 µL with Ion OneTouch™ Wash Solution from the Ion PGM™ Template OT2 Solutions 200 Kit (Part no. 4481105) and transfer 2 µL to a 0.2-mL PCR tube.

3. Add Ion Probes to sample(s).
  - If processing one sample, add 19 µL Annealing Buffer and 1 µL Ion Probes directly to the 0.2-mL PCR tube containing the ISPs and mix well by pipetting up and down.
  - If processing more than one sample, generate an Ion Probe Master Mix:
    - a.  $(19 \mu\text{L Annealing Buffer} * \# \text{ samples}) + (1 \mu\text{L Ion Probes} * \# \text{ samples}) =$  total volume required  
**Note:** Prepare an additional 5–10% overage to accommodate pipetting error.
    - b. Add 20 µL of Ion Probe Master Mix to the 0.2-mL PCR tubes containing the ISPs, then mix well by pipetting up and down.

4. Load the tube(s) into a thermal cycler, then perform the following protocol to anneal the Ion Probes:

Stage	Temperature	Time
Hold	95°C	2 min
Hold	37°C	2 min

5. Remove unbound probes by washing the sample(s) three times with 200 µL of Quality Control Wash Buffer.
  - a. Add 200 µL of Quality Control Wash Buffer to the 0.2-mL tube(s).
  - b. Vortex to mix, then centrifuge at  $15,500 \times g$  for 1.5 minutes.
  - c. Being careful not to disturb the pelleted ISPs, remove the supernatant and leave behind 10 µL.  
**Note:** Compare to a 10-µL standard for reference.
  - d. Repeat steps a – c two times for a total of three washes.
6. After the final wash, add 190 µL of Quality Control Wash Buffer for a total volume of 200 µL, mix by pipetting up and down five times and transfer the entire sample to a Qubit™ assay tube.

---

**IMPORTANT!** Ensure that you measure the volumes accurately.

---

7. To generate a negative control, add 200 µL of Quality Control Wash Buffer to a fresh Qubit™ assay tube.
8. Read the sample(s) as described below.

## Measure the sample

---

**IMPORTANT!** Prior to using the Qubit™ 2.0 Fluorometer, ensure that the instrument is running Firmware V3.10, and the Ion\_PluginV310\_AF.qbt file has been permanently uploaded to the instrument. See section “Upgrade the Qubit™ 2.0 Fluorometer firmware and software” on page 58 for more information about managing Qubit™ 2.0 Fluorometer firmware versions.

---

1. Power on the Qubit™ 2.0 Fluorometer.
2. Touch **Ion** to access Alexa Fluor™ 488 and Alexa Fluor™ 647 measurement options.
3. Touch **AF 488** and insert the sample into the Qubit™ 2.0 Fluorometer, close the lid, and touch **Read**.

**Note:** The lettering on the Read  selection option changes from white to red when reading a sample. The lettering changes back to white when the reading of the sample is finished in approximately 5 seconds.

**Note:** If more than one sample is being processed, all samples can be read with the AF 488 setting before moving on to the AF 647 setting.

4. Record the value.

**Note:** The data retained on the Qubit™ 2.0 Fluorometer can be transferred to a USB drive. See the “(Optional) Transfer the data to a USB Drive” on page 68 for details. If more than one sample is being processed, all samples can be read with the AF 488 setting before moving on to the AF 647 setting.

5. Touch **Home**, touch **Ion**, and then touch **AF 647**. Insert the sample into the Qubit™ 2.0 Fluorometer, close the lid, and touch **Read**.

**Note:** The lettering on the Read  selection option changes from white to red when reading a sample. The lettering changes back to white when the reading of the sample is finished in approximately 5 seconds.

6. Record the value.

---

**IMPORTANT!** Ensure that you read the negative control (Quality Control Wash Buffer only) in both the Alexa Fluor™ 488 and Alexa Fluor™ 647 settings and record the RFU values.

---

**(Optional) Transfer the data to a USB Drive**

1. Ensure that the USB drive is inserted in the instrument.
2. In the main menu, touch Data (at the bottom-right corner of the screen).
3. In the data screen, touch **USB drive**, then wait for the instrument to download the data to the USB drive:

**Note:** The download creates a “.csv” file that can be opened on your computer using any spreadsheet software, such as Microsoft™ Excel™ software.

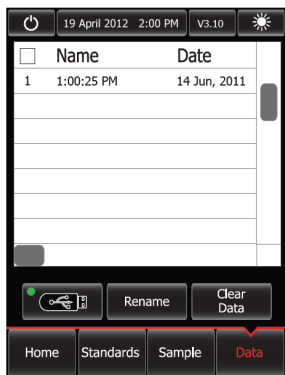

**Templated ISP evaluation**

1. Open the saved Qubit™ Easy Calculator Microsoft™ Excel™ Spreadsheet file containing the Calibration Factor specifically calculated for the Qubit™ 2.0 Fluorometer used.
2. Enter the raw RFU values from Alexa Fluor™ 488 and Alexa Fluor™ 647 Calibration Standards measurements in the appropriate fields for both the ISPs containing samples (red cells) and negative control sample (purple cells).

**IMPORTANT!** The Alexa Fluor™ 488 value must be >100 counts to produce a valid % Templated ISPs value. If the Alexa Fluor™ 488 value is <100 counts, see the “ISP Quality Control assay troubleshooting table” on page 77.

Fluorophore	Acceptable RFU Range
Alexa Fluor™ 488	>100 counts; no upper limit Samples with <100 counts usually correlate with no or very few ISPs in the assay.
Alexa Fluor™ 647	Any value, with the condition that the Alexa Fluor™ 488 RFU value is >100 counts.

3. In the appropriate field (blue cells), enter the lot-specific conversion factor for unenriched Ion PGM™ Template OT2 200 Ion Sphere™ Particles, available at: [ioncommunity.thermofisher.com/docs/DOC-9093](http://ioncommunity.thermofisher.com/docs/DOC-9093). (Log in is required.)

4. The Percent Templated ISPs calculates automatically and is displayed for each sample:

Qubit Calibration Factor Calculation						
Calibration Standard	RFU	Calibration Factor				
Alexa Fluor® 488 Calibration Standard	6548	0.58		Previously calculated Calibration Factor. Different for each Qubit® Fluorometer.		
Alexa Fluor® 647 Calibration Standard	10265					
Percent Templated ISPs						
Sample ID	Raw RFU Value		Background RFU (Negative Control Tube)		Conversion Factor*	Percent Templated ISPs
	AF 488	AF 647	AF 488	AF 647		
						#DIV/0!
						#DIV/0!
						#DIV/0!
						#DIV/0!
* Conversion factor can be found on Ion Community website ( <a href="http://ioncommunity.thermofisher.com/docs/DOC-9093">http://ioncommunity.thermofisher.com/docs/DOC-9093</a> ) and is Template Kit lot specific.						
Green Cells = Raw RFU values of FAM and Cy5 Calibration Standards supplied in the Ion Sphere Quality Control Kit						
Red Cells = Raw RFU values measured in "Measure the templated unenriched sample"						
Purple Cells = Raw RFU values measured for negative control in "Measure the templated unenriched sample"						
Blue Cells= Template kit lot specific conversion factor						

See "Acceptance criteria for unenriched Ion PGM™ Template OT2 200 Ion Sphere™ Particles" on page 76 for the optimal range of Percent Templated ISPs.

## Quality control using the Qubit™ 3.0 Fluorometer

The Qubit™ 3.0 Fluorometer features a pre-loaded Ion Sphere™ quality control assay for determining the percentage of templated ISPs. As with the Qubit™ 2.0 Fluorometer, a unique instrument-specific Calibration Factor must be calculated and applied to all percent templated ISP calculations.

### Materials required

- Qubit™ 3.0 Fluorometer (Cat. no. Q33216)
- Qubit™ Assay Tubes (Cat. no. Q32856)
- PCR tubes, 0.2 mL (Axygen Cat. no. PCR-02-L-C or BioExpress Cat. no. T-3035-1)
- Qubit™ Easy Calculator Microsoft™ Excel™ Spreadsheet file containing the instrument-specific Calibration Factor
- Ion Sphere™ Quality Control Kit (Cat. no. 4468656)
- Unenriched Ion Sphere™ Particles
- GeneAmp™ PCR System 9700 thermal cycler (Cat. no. N8050200) or equivalent

### Calculate the Qubit™ 3.0 Fluorometer Calibration Factor

This section describes the procedure to determine the Qubit™ 3.0 Fluorometer instrument-specific Calibration Factor.

**Note:** It is only necessary to calculate the Calibration Factor once for a particular instrument, unless a problem is suspected.

### Download the Qubit™ Easy Calculator

Download the Qubit™ Easy Calculator Microsoft™ Excel™ Spreadsheet file from: <http://ioncommunity.thermofisher.com/community/products/pgm> (Logging into the Ion Community is required), and save the file to the computer used for Qubit™ 3.0 Fluorometer data analysis.

### Prepare the calibration standard

1. From the Ion Sphere™ Quality Control Kit, thaw the Alexa Fluor™ 488 and Alexa Fluor™ 647 Calibration Standard reagents.

**Note:** Both the Alexa Fluor™ 488 and Alexa Fluor™ 647 molecules are photosensitive, so avoid exposure to light for long periods of time and direct sunlight.

2. Vortex well to mix and pulse-spin the tube to remove any liquid trapped in the cap.
3. Transfer 200 µL of each standard into two separate Qubit™ assay tubes. Pulse-spin to bring all the liquid to the bottom of the tube.

### Measure the calibration standard

1. Power on the Qubit™ 3.0 Fluorometer.
2. Touch **Ion Sphere** on the Qubit™ 3.0 Fluorometer home screen open the Ion Sphere™ Assay. Touch **AF 488**.

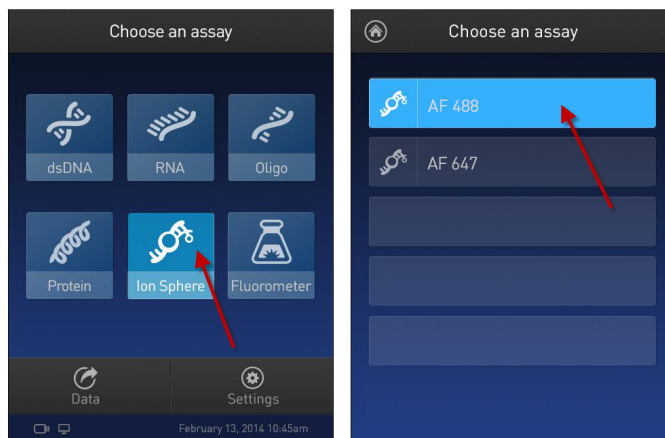

3. Insert the Alexa Fluor™ 488 Calibration Standard reagent into the Qubit™ 3.0 Fluorometer, close the lid, and touch **Read tube** ( [Read tube](#) ).

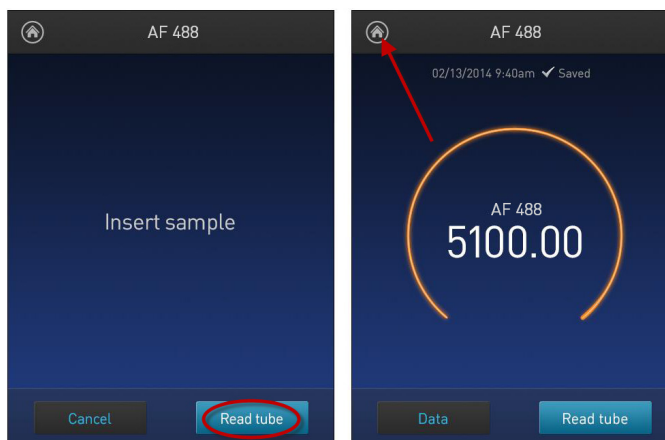

4. Record the RFU value, remove the assay tube from the Qubit™ 3.0 Fluorometer and touch the **Home**  icon in the upper left corner of the screen.

5. On the Home screen, touch **Ion Sphere**, and then touch **AF 647**. Insert the Alexa Fluor™ 647 Calibration Standard into the Qubit™ 3.0 Fluorometer, close the lid, and touch **Read tube** (  ).

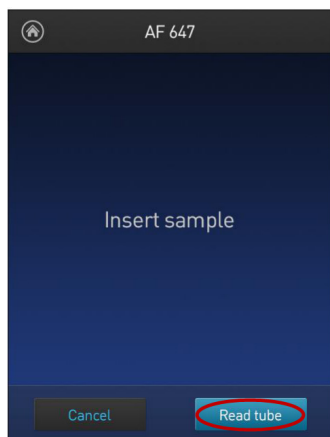

6. Record the RFU value, remove the assay tube from the Qubit™ 3.0 Fluorometer. Touch **Data** (  ).

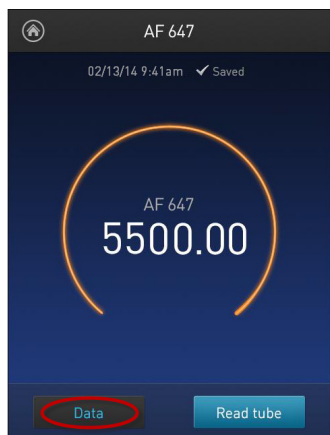

7. Touch **Export** (  ) to export data to a USB storage drive or to a USB-connected computer. Touch **Done** (  ) to return to the Home screen.





### Calculate the Calibration Factor

1. In the Qubit™ Easy Calculator, enter each recorded RFU value in the appropriately labeled green cell to display the Calibration Factor specific for the Qubit™ 3.0 Fluorometer.
2. Save a copy of the Qubit™ Easy Calculator containing the Calibration Factor for use as a template for future Percent Templated ISPs calculations:

**Note:** Affix a sticker with the instrument-specific Calibration Factor to the Qubit™ 3.0 Fluorometer.

Qubit Calibration Factor Calculation						
Calibration Standard	RFU	Calibration Factor				
Alexa Fluor® 488 Calibration Standard		#DIV/0!				
Alexa Fluor® 647 Calibration Standard						
Percent Templated ISPs						
	Raw RFU Value		Background RFU (Negative Control Tube)			
Sample ID	AF 488	AF 647	AF 488	AF 647	Conversion Factor*	Percent Templated ISPs
						#DIV/0!
						#DIV/0!
						#DIV/0!
						#DIV/0!
* Conversion factor can be found on Ion Community website ( <a href="http://ioncommunity.thermofisher.com/docs/DOC-9093">http://ioncommunity.thermofisher.com/docs/DOC-9093</a> ) and is Template Kit lot-specific.						
Green Cells = Raw RFU values of FAM and Cy5 Calibration Standards supplied in the Ion Sphere Quality Control Kit						
Red Cells = Raw RFU values measured in "Measure the templated unenriched sample"						
Purple Cells = Raw RFU values measured for negative control in "Measure the templated unenriched sample"						
Blue Cells= Template kit lot specific conversion factor						

**IMPORTANT!** For each Qubit™ 3.0 Fluorometer used, save a separate Qubit™ Easy Calculator Microsoft™ Excel™ Spreadsheet file containing the Calibration Factor specifically calculated for that particular instrument.

### Measure the templated unenriched sample

This section describes the procedure for determining the percent templated ISPs for unenriched Ion Sphere™ Particles.

#### Prepare the sample

1. From the Ion Sphere™ Quality Control Kit, thaw the Ion Probes tube, Annealing Buffer, and Quality Control Wash Buffer.
2. For unenriched Ion PGM™ Template OT2 200 Ion Sphere™ Particles, if not 100 µL, adjust sample volume to 100 µL with Ion OneTouch™ Wash Solution from the Ion PGM™ Template OT2 Solutions 200 Kit (Part no. 4481105) and transfer 2 µL to a 0.2-mL PCR tube.

3. Add Ion Probes to sample(s).
  - If processing one sample, add 19 µL Annealing Buffer and 1 µL Ion Probes directly to the 0.2-mL PCR tube containing the ISPs and mix well by pipetting up and down.
  - If processing more than one sample, generate an Ion Probe Master Mix:
    - a.  $(19 \mu\text{L Annealing Buffer} * \# \text{ samples}) + (1 \mu\text{L Ion Probes} * \# \text{ samples}) =$  total volume required

**Note:** Prepare an additional 5–10% overage to accommodate pipetting error.

    - b. Add 20 µL of Ion Probe Master Mix to the 0.2-mL PCR tubes containing the ISPs, then mix well by pipetting up and down.
4. Load the tube(s) into a thermal cycler, then perform the following protocol to anneal the Ion Probes:

Stage	Temperature	Time
Hold	95°C	2 min
Hold	37°C	2 min

5. Remove unbound probes by washing the sample(s) three times with 200 µL of Quality Control Wash Buffer.
  - a. Add 200 µL of Quality Control Wash Buffer to the 0.2-mL tube(s).
  - b. Vortex to mix, then centrifuge at  $15,500 \times g$  for 1.5 minutes.
  - c. Being careful not to disturb the pelleted ISPs, remove the supernatant and leave behind 10 µL.

**Note:** Compare to a 10-µL standard for reference.

  - d. Repeat steps a – c two times for a total of three washes.
6. After the final wash, add 190 µL of Quality Control Wash Buffer for a total volume of 200 µL, mix by pipetting up and down five times and transfer the entire sample to a Qubit™ assay tube.

---

**IMPORTANT!** Ensure that you measure the volumes accurately.

---

7. To generate a negative control, add 200 µL of Quality Control Wash Buffer to a fresh Qubit™ assay tube.
8. Read the sample(s) as described below.

### Measure the sample

1. Power on the Qubit™ 3.0 Fluorometer.
2. Touch **Ion Sphere** to access Alexa Fluor™ 488 and Alexa Fluor™ 647 measurement options.

3. Touch **AF 488** and insert the sample into the Qubit™ 3.0 Fluorometer, close the lid, and touch **Read tube**.

**Note:** If more than one sample is being processed, all samples can be read with the AF 488 setting before moving on to the AF 647 setting.

4. Record the value.

**Note:** The data retained on the Qubit™ 3.0 Fluorometer can be transferred to a USB drive. See the “(Optional) Transfer the data to a USB Drive” for details. If more than one sample is being processed, all samples can be read with the AF 488 setting before moving on to the AF 647 setting.

5. Touch **Home**, touch **Ion Sphere**, and then touch **AF 647**. Insert the sample into the Qubit™ 3.0 Fluorometer, close the lid, and touch **Read tube**.

6. Record the value.

---

**IMPORTANT!** Ensure that you read the negative control (Quality Control Wash Buffer only) in both the Alexa Fluor™ 488 and Alexa Fluor™ 647 settings and record the RFU values.

---

### (Optional) Transfer the data to a USB Drive

1. Ensure that the USB drive is inserted in the instrument, or a computer is connected by USB cable.
2. On the Home screen, touch **Data** (at the bottom-left of the screen).
3. On the Data screen, touch **Export**, then wait for the instrument to download the data to the USB drive or computer.

**Note:** The download creates a “.csv” file that can be opened on your computer using any spreadsheet software, such as Microsoft™ Excel™ software.

### Evaluate the templated ISPs

1. Open the saved Qubit™ Easy Calculator Microsoft™ Excel™ Spreadsheet file containing the Calibration Factor specifically calculated for the Qubit™ Fluorometer used.
2. Enter the raw RFU values from Alexa Fluor™ 488 and Alexa Fluor™ 647 Calibration Standards measurements in the appropriate fields for both the ISPs containing samples (red cells) and negative control sample (purple cells).

---

**IMPORTANT!** The Alexa Fluor™ 488 value must be >100 counts to produce a valid % Templated ISPs value. If the Alexa Fluor™ 488 value is <100 counts, see “ISP Quality Control assay troubleshooting table” on page 77.

---

Fluorophore	Acceptable RFU Range
Alexa Fluor™ 488	>100 counts; no upper limit Samples with <100 counts usually correlate with no or very few ISPs in the assay.
Alexa Fluor™ 647	Any value, with the condition that the Alexa Fluor™ 488 RFU value is >100 counts.

- In the appropriate field (blue cells), enter the lot-specific conversion factor for unenriched Ion PGM™ Template OT2 200 Ion Sphere™ Particles, available at: <http://ioncommunity.thermofisher.com/docs/DOC-9093>. (Log in is required.)
- The Percent Templated ISPs calculates automatically and is displayed for each sample:

Qubit Calibration Factor Calculation						
Calibration Standard	RFU	Calibration Factor				
Alexa Fluor® 488 Calibration Standard	6548	0.58	Previously calculated Calibration Factor. Different for each Qubit® Fluorometer.			
Alexa Fluor® 647 Calibration Standard	10265					
Percent Templated ISPs						
Sample ID	Raw RFU Value		Background RFU (Negative Control Tube)		Conversion Factor*	Percent Templated ISPs
	AF 488	AF 647	AF 488	AF 647		
						#DIV/0!
						#DIV/0!
						#DIV/0!
						#DIV/0!

\* Conversion factor can be found on Ion Community website (<http://ioncommunity.thermofisher.com/docs/DOC-9093>) and is Template Kit lot specific.

Green Cells = Raw RFU values of FAM and Cy5 Calibration Standards supplied in the Ion Sphere Quality Control Kit  
 Red Cells = Raw RFU values measured in "Measure the templated unenriched sample"  
 Purple Cells = Raw RFU values measured for negative control in "Measure the templated unenriched sample"  
 Blue Cells = Template kit lot specific conversion factor

## Acceptance criteria for unenriched Ion PGM™ Template OT2 200 Ion Sphere™ Particles

The optimal amount of library corresponds to the library dilution point that gives Percent Templated ISPs between 10–30%.

Samples that fall within the recommended range generally produce the most data; however, samples that fall outside of the recommended range can still meet the throughput specifications on the Ion chips.

The recommended optimal range is not intended to be a pass/fail criteria. The range provides guidance for the quality of the sample.

**Note:** If the results are outside the desired Percent Templated ISPs range, then increase or decrease the library input appropriately.

Percent Templated ISPs	Description
<10%	Sample contains an insufficient number of templated ISPs to achieve optimal loading density on the Ion Chip.
10–30%	Optimal amount of library.
>30%	Sample will yield multi-templated ISPs (mixed reads).

## ISP Quality Control assay troubleshooting table

The following table contains a troubleshooting information for the unenriched Ion Sphere™ Quality Control assay on the Qubit™ 2.0 or Qubit™ 3.0 Fluorometer.

Qubit™ Fluorometer observation	Ion PGM™ System observation	Possible cause	Recommended action
<10% Templated ISPs	<ul style="list-style-type: none"> <li>Lower loading</li> <li>Lower % enriched</li> <li>Lower key signal</li> <li>Lower throughput</li> </ul>	Too little library input into template preparation	<ul style="list-style-type: none"> <li>Increase library input to target 20–25% templated ISPs.</li> <li><i>or</i></li> <li>Continue with sequencing; expect lower throughput.</li> </ul>
>30% Templated ISPs, but <70%	Increased number of filtered reads	Too much library input into template preparation	<ul style="list-style-type: none"> <li>Decrease library input to target 20–25% templated ISPs.</li> <li><i>or</i></li> <li>Continue with sequencing; expect lower throughput.</li> </ul>
>70% Templated ISPs	<ul style="list-style-type: none"> <li>Increased % primer dimer filtered reads</li> <li>Lower throughput</li> </ul>	Adapter dimer contaminating library, more likely in short amplicon, Ion AmpliSeq™ or miRNA libraries	<ul style="list-style-type: none"> <li>Check Bioanalyzer™ traces for adapter dimer peak (Amplicon library or Ion AmpliSeq™ library peak around 70 bp; miRNA library peak around 60bp).</li> <li>Re-purify Agencourt™ library using AMPure™ XP Kit clean-up steps as outlined in the appropriate user guides.</li> </ul>
	<ul style="list-style-type: none"> <li>Low loading</li> <li>Low % enriched</li> <li>Lower throughput</li> <li>High % filtered reads</li> </ul>	Ion OneTouch™ 2 Instrument underperformance	Troubleshoot with Technical Support or a Field Application Scientist.

## Quality control using the Guava™ easyCyte™ 5 Flow Cytometer

The Guava™ easyCyte™ 5 Flow Cytometer can be used for quality assessment of unenriched and enriched Ion PGM™ Template OT2 200 Ion Sphere™ Particles generated for up to 200 base-read sequencing on the Ion PGM™ System. For details, refer to the *Ion Sphere™ Particles (ISPs) Quality Assessment Using the Guava™ easyCyte™ 5 Flow Cytometer User Bulletin* (Pub. no. 4470082), available on the Ion Community website:

[ioncommunity.thermofisher.com](http://ioncommunity.thermofisher.com)

## Quality control using the Attune™ Acoustic Focusing Cytometer

The Applied Biosystems™ Attune™ Acoustic Focusing Cytometer can be used for quality assessment of unenriched and enriched Ion PGM™ Template OT2 200 Ion Sphere™ Particles generated for up to 200 base-read sequencing on the Ion PGM™ Sequencer. For details, refer to the *Demonstrated Protocol: Ion Sphere™ Particles (ISPs) Quality Assessment using the Applied Biosystems™ Attune™ Acoustic Focusing Cytometer User Bulletin* (Pub. no. 4477181), available on the Ion Community website:

**[ioncommunity.thermofisher.com](http://ioncommunity.thermofisher.com)**

---

**IMPORTANT!** Thermo Fisher Scientific Demonstrated Protocols have been successfully demonstrated by research and development but not verified. There are no technical specifications for demonstrated protocols. Users assume all risk when using these protocols, and recognize that support for Thermo Fisher Scientific Demonstrated Protocols occurs through community discussion. All customers are encouraged to discuss and contribute via the Ion Community.

---



# Set up, calibrate, and maintain the Ion OneTouch™ ES

■ Set up the Ion OneTouch™ ES	79
■ Perform a residual volume test	83
■ Calibrate the Ion OneTouch™ ES Instrument	87
■ Maintain the Ion OneTouch™ ES	90
■ Decontaminate the Ion OneTouch™ ES	95

---

**IMPORTANT!** Ensure that the fuse module for the Ion OneTouch™ ES is properly installed, according to 110–120 V or 240 V line voltages. Refer to *Unpack and Install the Ion OneTouch™ 2 System Product Insert* (Pub. no. 4481875).

---

## Set up the Ion OneTouch™ ES

Before the first ISP enrichment run, set up the instrument.

### Materials required for this procedure

**Provided in Ion PGM™ Template OT2 Solutions 200 Kit (Part no. 4481105):**

- Nuclease-free Water

**Provided in Ion PGM™ Template OT2 Supplies 200 Kit (Part no. 4480981):**

- 8-well strip
- Eppendorf™ LoRetention Dualfilter Tips (P300)

**Provided in the Ion OneTouch™ 2 System (Part no. 4474779):**

- Corning Brand 96-Well Strip Ejector (Thermo Fisher Cat. no. 07-200-22), unless 8-well strips are supplied loose and out of the frame



**Other Materials and Equipment:**

- Ion OneTouch™ ES
- Elbow fitting for Ion OneTouch™ ES
- 0.2-mL PCR tubes
- Pipettes
- Vortexer
- [Optional] Felt-tipped pen

**Set up the instrument**

Ensure that the AC line voltage fuse module is installed in the proper orientation. Refer to the *Ion OneTouch™ 2 System User Guide* (Pub. no. MAN0014388).

1. Locate the Tray, Tip Arm, and Tip Loader of the Ion OneTouch™ ES.
2. Install the Tray:
  - a. Wipe the instrument and the bottom of the Tray with a damp lab wipe to remove any packaging debris.
  - b. Place the Tray on the Ion OneTouch™ ES with the calibration shelf on the left as shown in the following photograph.
  - c. Push the Tray down firmly so that the Tray fits snugly in the clamps, then confirm that the Tray is level:

---

**IMPORTANT!** For proper operation of the Ion OneTouch™ ES, the tray must be firmly and uniformly seated in the cutout for the tray.

---

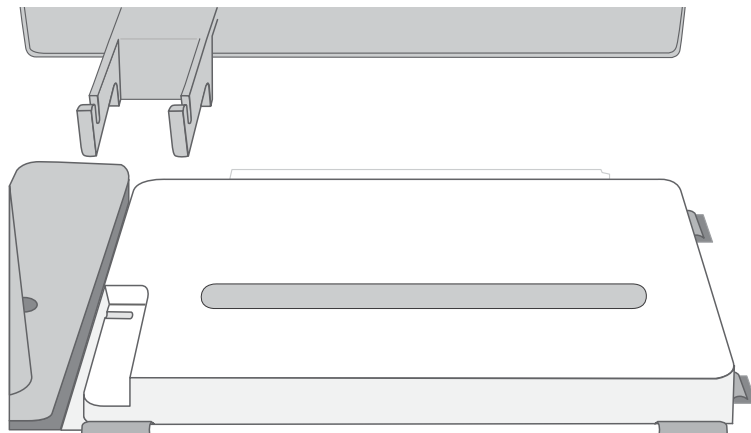



3. Place the Tip Loader in the slot on the left side of the instrument deck:

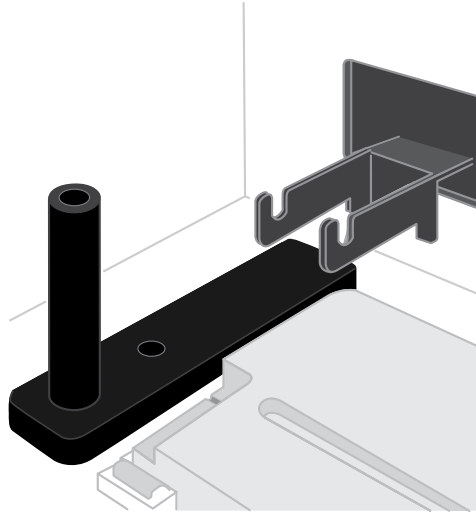

4. Install the supplied elbow fitting and place the Tip Arm in the cradle.
  - a. Insert the male end of the elbow fitting into the female connector on the Tip Arm, then finger tighten the lock ring on the elbow fitting:

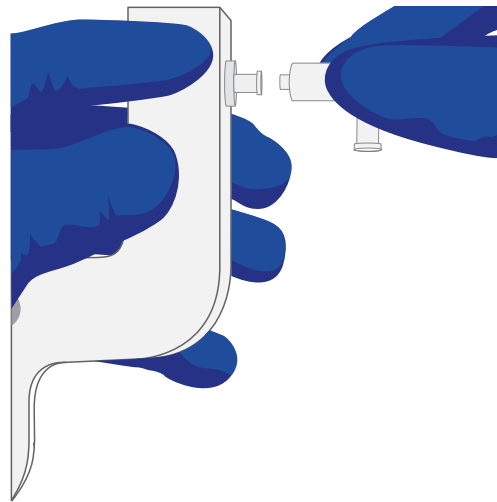

- b. Connect the tubing to the elbow fitting on the top of the Tip Arm:

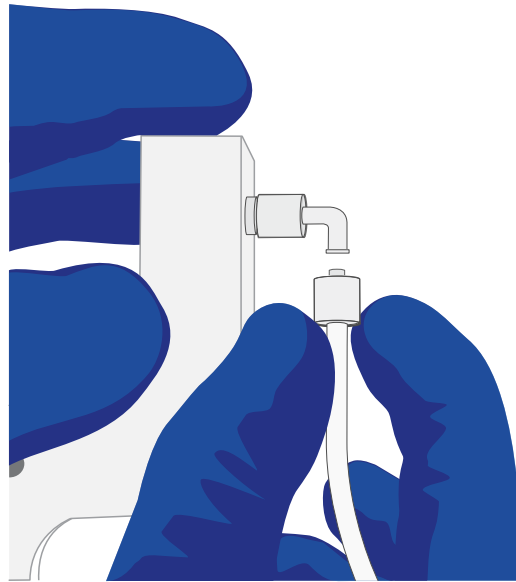

- c. Finger-tighten the connectors *at both ends* of the elbow.

---

**IMPORTANT!** Do not twist or coil the tubing.

---

- d. Tilt the Tip Arm back. Align the pins with the round notches in the cradle, then lower the Tip Arm into position. Move the Tip Arm forward into the working position (see the following illustration):

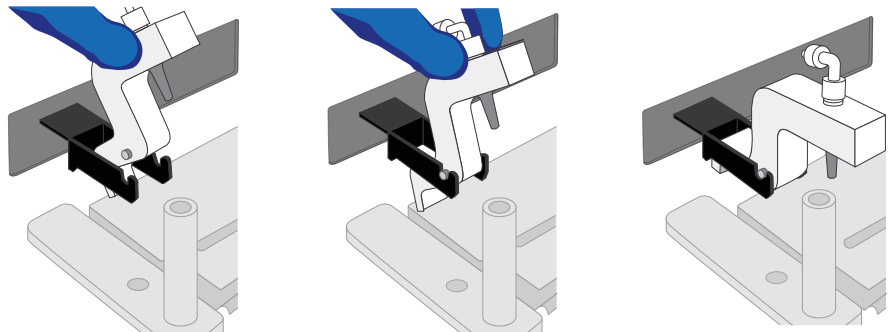

**Note:** Ensure that the back/bottom end of the Tip Arm is not resting on top of the thumb screw, causing the Tip Arm to tilt forward. Do *not* adjust the angle of the arm unless you need to calibrate the instrument.

5. Ensuring that the power switch is turned OFF, plug the power cord into the instrument.
6. Plug the other end of the instrument power cord into the surge protector or line conditioner.



7. Plug the surge protector or line conditioner into an electrical outlet.

---

**IMPORTANT!** The voltage of the electrical outlet must match the voltage of the surge protector and the selected voltage of the installed AC line voltage fuse module in the Ion OneTouch™ ES.

---

8. Turn the power switch ON. (*Optional*) Leave the instrument ON indefinitely.

## Perform a residual volume test

If the condition is...	Then...
First use of the instrument and during monthly maintenance	Perform a residual volume test (see instructions below).
Routine use and residual volume in Well 1 and Well 8 is >5.0 µL	
Routine use and residual volume in Well 1 and Well 8 is ≤5.0 µL	Operate the instrument without performing the residual volume test.

1. Set up the Ion OneTouch™ ES (see “Set up the instrument” on page 80).
2. Install a new tip in the Tip Arm:
  - a. Place a new tip in the Tip Loader. Remove the Tip Arm from the cradle and align the metal fitting of the Tip Arm with the tip.
  - b. Keeping the fitting on the Tip Arm vertical, firmly press the Tip Arm down onto the new tip until the Tip Arm meets the Tip Loader. Hold the Tip Arm to the Tip Loader for ~1 second to ensure proper installation of the tip.
  - c. Lift the Tip Arm *straight* up to pull the installed tip from the Tip Loader tube:

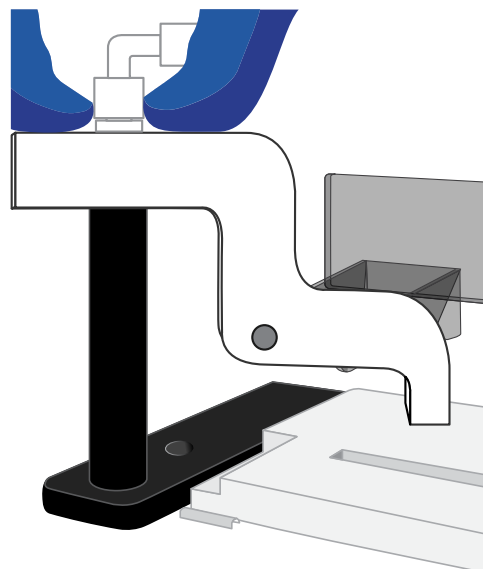

- d. Return the Tip Arm to the cradle (see the following illustration):
1. Tilt the Tip Arm back (below left) and align the pins with the round notches in the cradle (below middle).
  2. Lower the Tip Arm into position (below right).
  3. Move the Tip Arm forward into the working position:

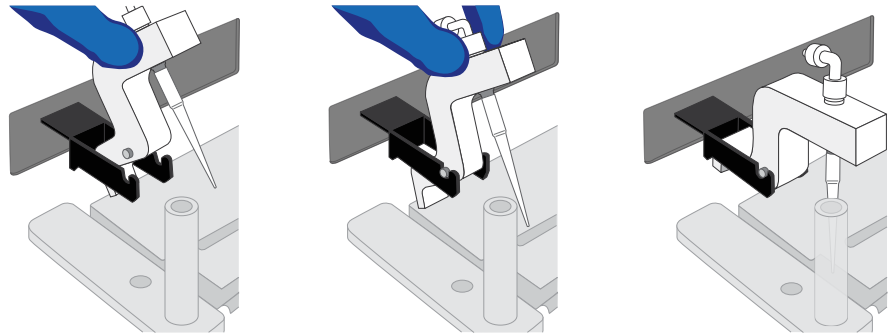

**IMPORTANT!** Ensure that the back/bottom end of the Tip Arm is not resting on top of the thumb screw, causing the Tip Arm to tilt forward.

**Note:** For the residual volume test, you do *not* need to put a 0.2-mL PCR tube into the hole of the Tip Loader.

3. Load an 8-well strip on the Ion OneTouch™ ES:
- a. Load 80  $\mu$ L water or Ion OneTouch™ Wash solution into the second well (Well 2) from the square-tabbed end of the 8-well strip:

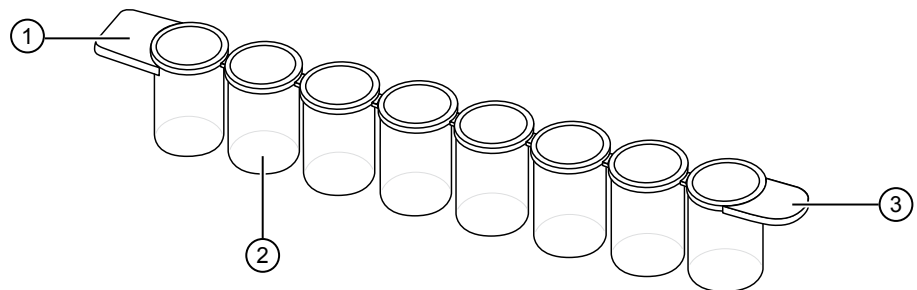

- ① Square-shaped tab
- ② Well 2
- ③ Rounded tab

- b. Load the 8-well strip into the slot of the Tray so that the square-tabbed end is to the *left* and the 8-well strip is pushed all the way to the right until it touches the end of the slot.

**IMPORTANT!** Before running the residual volume test, carefully read and familiarize yourself with step 4 of this procedure.

4. Run the residual volume test. During the test, confirm that the tip is centered between the sides of the wells when moving in or out of a well.
- a. Turn the instrument ON.



- b. Wait for the instrument to initialize: The screen displays “rdy”. The Tip Arm performs a series of movements and returns to the home position (~5 seconds).
  - c. Press **Start/Stop**.
  - d. Wait for the instrument to aspirate the solution from Well 2 and completely remove the tip from Well 2, then *manually* push the 8-well strip to the left so that Well 4 is positioned directly under the Tip Arm.
  - e. Wait for the instrument to dispense the tip contents into Well 4.
  - f. Press **Start/Stop** to stop the test run, then press **Start/Stop** again to return the Tip Arm to the home position.
  - g. Using a P10 pipette, aspirate the entire residual water or Ion OneTouch™ Wash Solution from well 2, then estimate the residual volume.
5. Remove the used tip: With the Tip Arm in its cradle and while standing above the Tip Arm, twist the tip *counterclockwise* and pull it downward to remove and discard the tip:

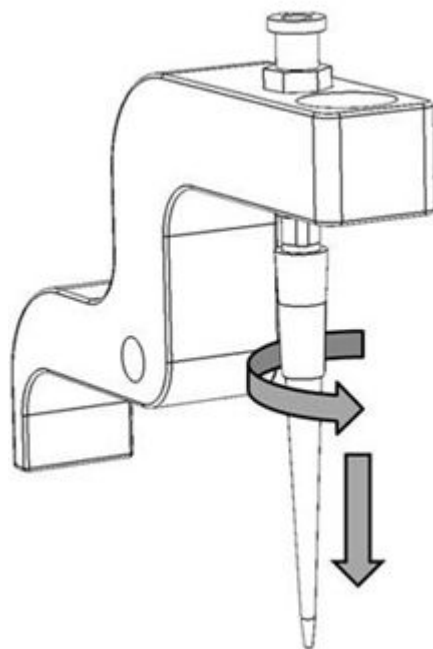

---

**IMPORTANT!** Improper removal of tips can loosen the metal tip adapter fitting on the Tip Arm and affect instrument operation.

---

6. Remove and discard the used 8-well strip.



7. After performing the residual volume test, take one or more of the following actions:

<b>Observation</b>	<b>Possible cause</b>	<b>Recommended actions</b>
Residual volume in Well 2 is $\leq 5 \mu\text{L}$	—	No action is necessary.
Residual volume in Well 2 is $> 5 \mu\text{L}$	The tip height is too high during aspiration.	Restore defaults, then calibrate the instrument (see “Calibrate the Ion OneTouch™ ES Instrument” on page 87).
Aspiration is irregular	This instrument out of calibration.	Restore defaults, then calibrate the instrument (see “Calibrate the Ion OneTouch™ ES Instrument” on page 87).
The 8-well strip lifts as the tip rises to the top of the well	The tip is angled too far forward or the tip height is set too low.	Verify that the tip is vertical and positioned directly over the notch in the calibration shelf. If the tip is positioned correctly. Restore defaults, then calibrate the instrument (see “Calibrate the Ion OneTouch™ ES Instrument” on page 87).

## Calibrate the Ion OneTouch™ ES Instrument

Perform horizontal and vertical calibrations so that during operation the tip is optimally positioned in the well (see the following illustration) of the 8-well strip:

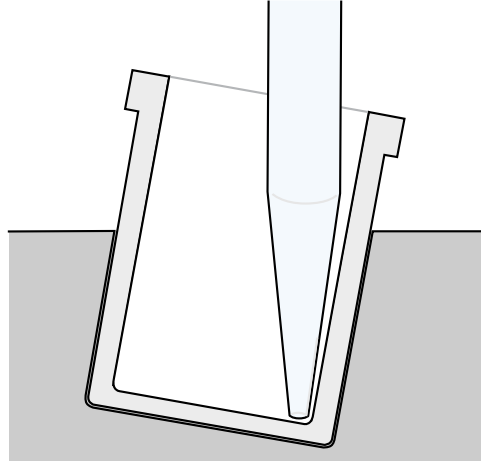

Note that the 8-well strip is always tilted at a fixed 10-degree angle in the slot. The pipette tip is vertical. When the tip is aligned properly during calibration so that it is in line with the notch in the calibration shelf, the tip touches the bottom of the well during the run, close to the front bottom edge of the well.

---

**IMPORTANT!** If you use more than one Ion OneTouch™ ES Instrument, do not switch Trays or Tip Arms between instruments. Each Tray and Tip Arm is calibrated with a particular instrument. To track the Tray and Tip Arm, each component has a printed label with the matching serial number of the instrument.

---

### Vertical axis calibration

1. Install a new tip.
2. Restore the factory default settings:
  - a. Power OFF the instrument. and wait 3 seconds.
  - b. While holding down **Vert. Adjust**, power ON the instrument.
3. Put the instrument into calibration mode:
  - a. Power the instrument OFF.
  - b. While holding down **Select/Calibrate**, power the instrument ON. Keep holding down **Select/Calibrate** until "P1" is displayed.
  - c. Press **Select/Calibrate** for ~3 seconds until the instrument beeps 2 times and "CAL" is displayed.

**Note:** The instrument will cycle through several values before "CAL" is displayed.
4. Press **Vert. Adjust**. The instrument displays "ASP" (Aspirate or z-bottom position).

5. Press **Start/Stop**. The Tip Arm lowers to bring the tip near the notch in the calibration shelf on the left side of the Tray.
6. Adjust if needed the position of the bottom of the pipette tip:

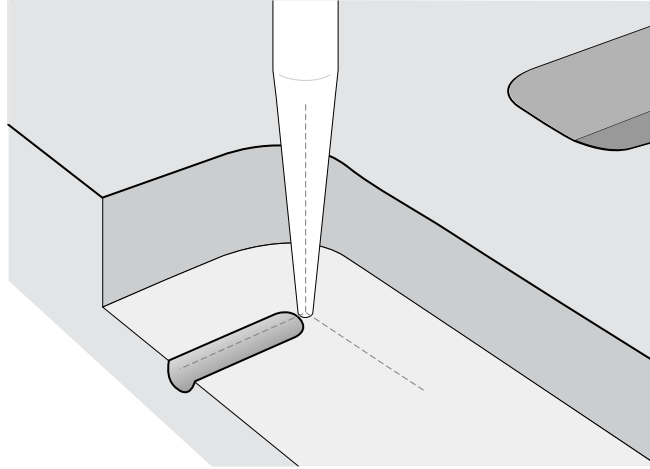

- a. To adjust the alignment of the tip with the slot, turn the thumbscrew at the back of the Tip Arm.

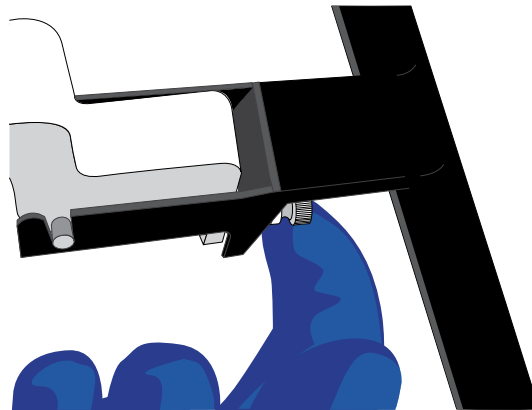

- b. To adjust the height of the tip, press the ▼ (minus) button repeatedly until the tip touches the shelf. Press the ▼ (minus) button eight more times to lower the tip further. This will account for variations in tip lengths and installation.

**Note:** It is better to have the ASP (aspiration) height be too low than too high.

7. Press **Start/Stop**, then wait for the Tip Arm to stop moving and for “P1” to display.





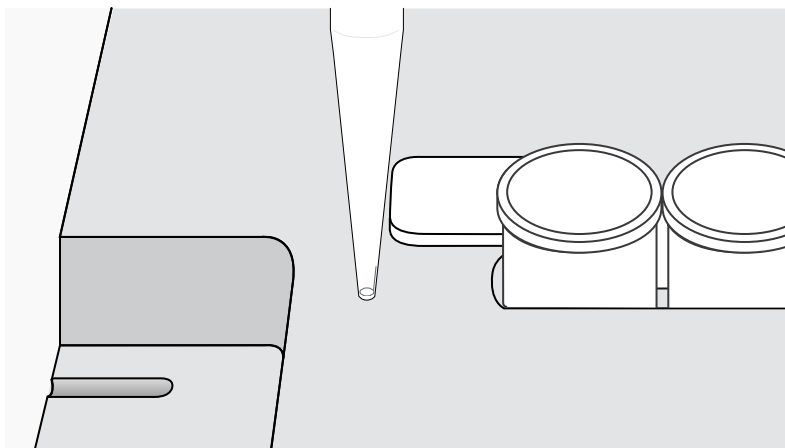

## Horizontal axis calibration

1. Press **Select/Calibrate** for ~3 seconds until the instrument beeps 2 times and “CAL” is displayed.  
**Note:** The instrument will cycle through several values before “CAL” is displayed.
2. Press **Horiz. Adjust**. Instrument displays “FLA”, then press **Start/Stop**.
3. Place an empty 8-well strip in the slot in the Tray, with the square tab on the left.
4. Push the 8-well strip to the far left in the slot as possible.
5. Observe the position of the 8-well strip relative to the position of the tip. When properly calibrated, the 8-well strip is  $\leq 1$  mm of touching but not pushing on the tip. To clearly see the relationship between the pipette tip, calibration shelf, and notch during calibration, mark each of them with a felt-tip pen:



6. Adjust the horizontal position of the Tip Arm so that the tip just touches the left tab of the 8-well strip when the 8-well strip is pushed to the far left of the slot in the Tray:
  - a. Apply slight pressure to keep the 8-well strip to the far left.
  - b. Press the  (plus) button repeatedly until the tip touches the 8-well strip. Each press of the  (plus) key moves the Tip Arm to the *right* by ~0.002 inches (~50  $\mu\text{m}$ ), which may be difficult to detect.
7. Press **Start/Stop** to save the setting and for “P1” to display.
8. Power the instrument OFF, wait >3 seconds, then power the instrument ON to return to normal operating mode.
9. Perform a residual volume test (see “Perform a residual volume test” on page 83).



## Maintain the Ion OneTouch™ ES

Materials and  
equipment  
required

Xiameter™ PMX-200 Silicone Fluid

Ion OneTouch™ ES  
back panel layout

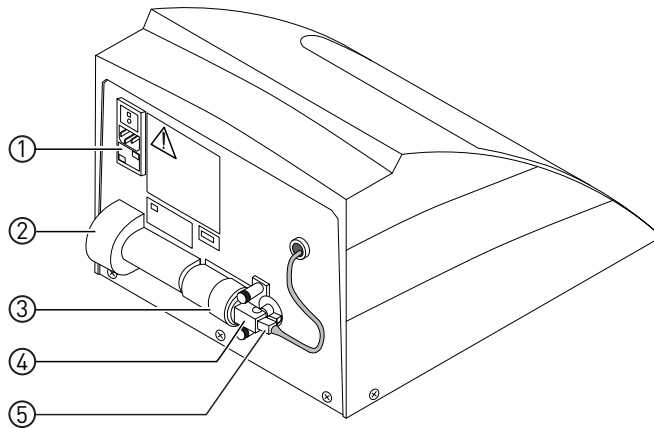

- ① Fuse module
- ② Syringe pump
- ③ Syringe assembly

- ④ Syringe valve & valve cover
- ⑤ Tubing connection

## Lubricate the syringe annually

1. Disassemble the syringe (located on the back of the instrument):

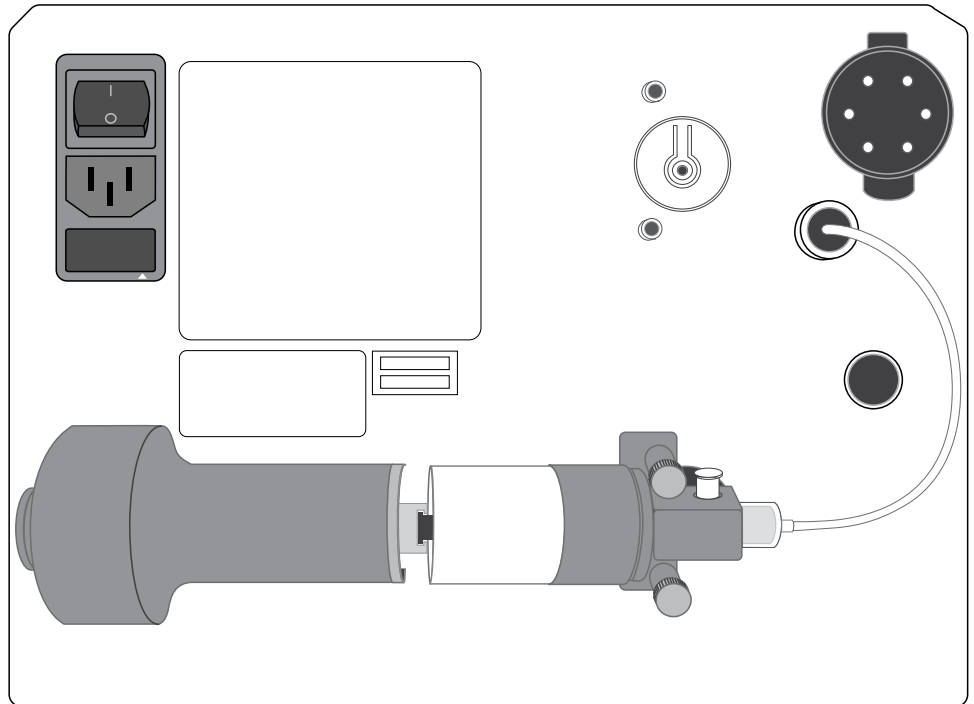

- a. Disconnect the tubing:

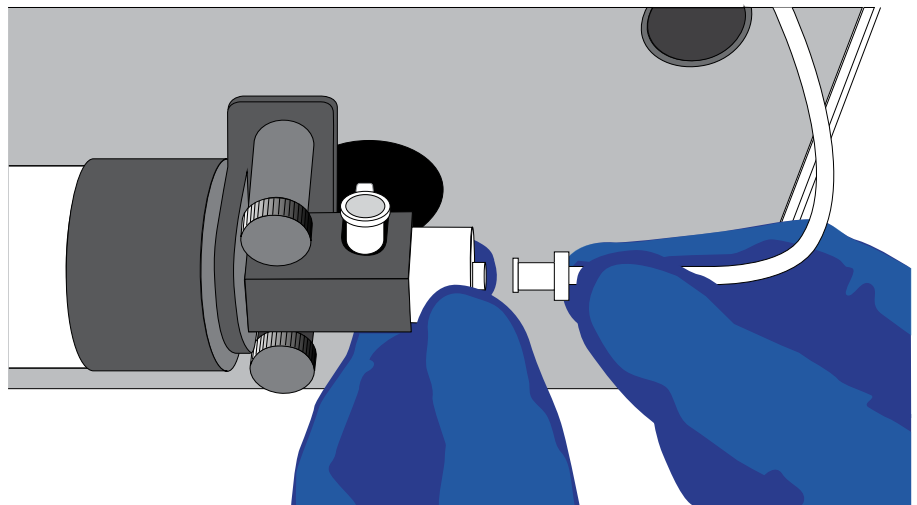

**b.** Remove the 2 screws:

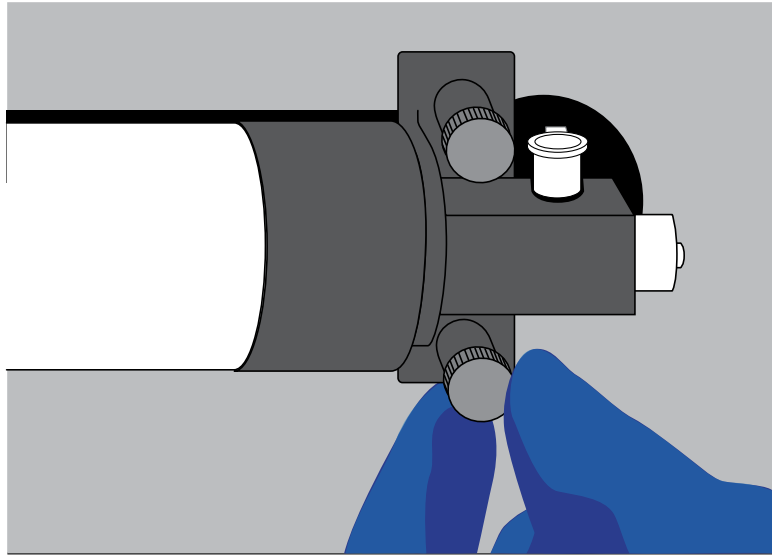

**c.** Remove the retainer:

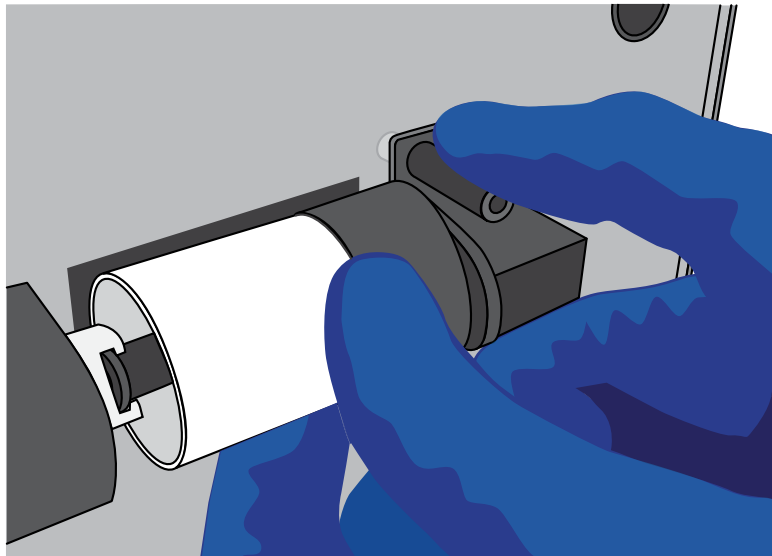

- d. Pull the syringe body toward you to remove from the instrument:

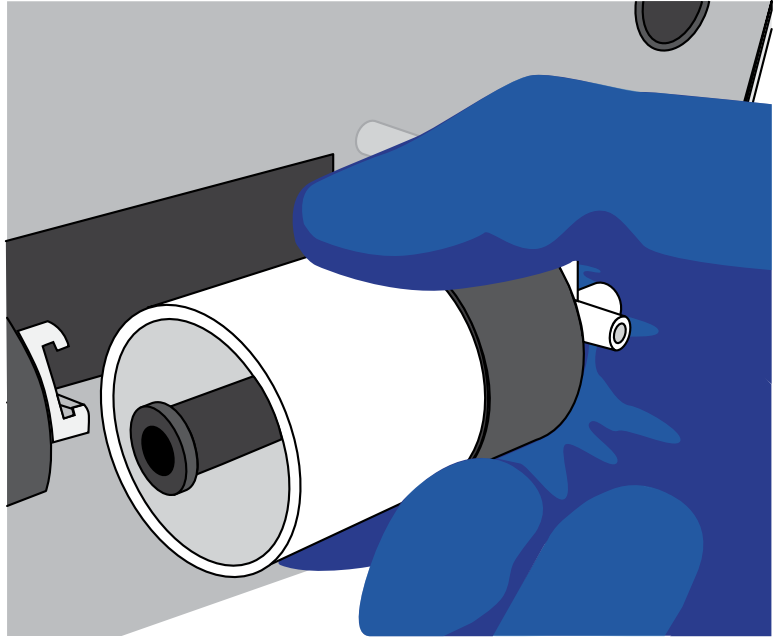

- e. Remove the plunger from the syringe body:

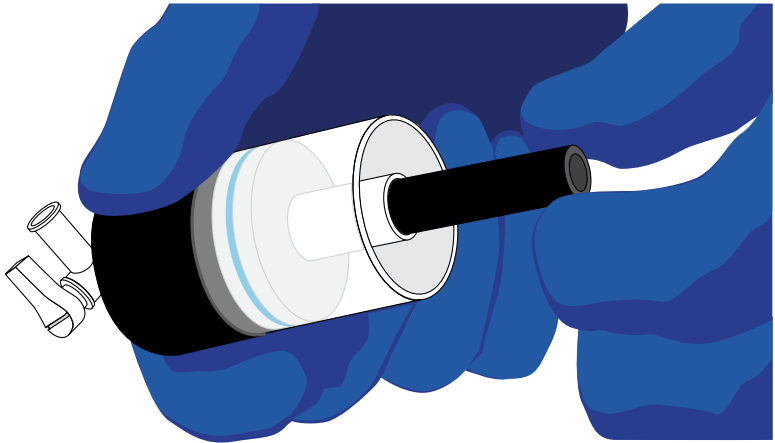



- f. Apply a thin layer of Xiameter™ PMX-200 Silicone Fluid to the inside of the syringe body:



- 2. Reassemble the syringe:
  - a. Push the plunger all the way into the syringe body, then pull back out approximately ¼ inch.
  - b. Engage the plunger with its mate end.

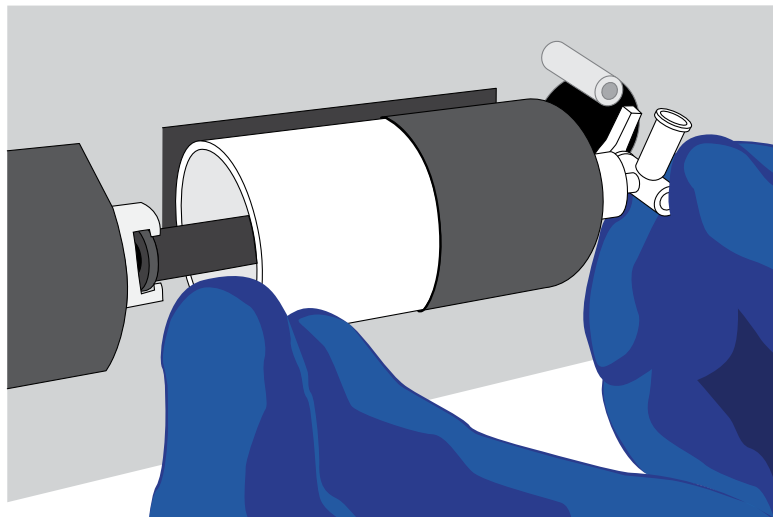



- c. Insert the valve into its docking position.

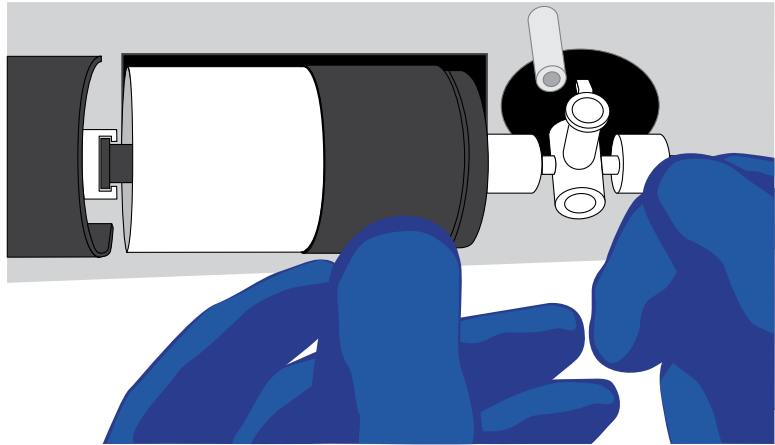

- d. Replace the retainer.  
e. Replace the 2 screws (finger-tighten).  
f. Reconnect the tubing.

## Decontaminate the Ion OneTouch™ ES

Before returning the instrument for service, decontaminate it according to the procedure below.

### Materials and equipment required

- Disposable rubber gloves
- Safety glasses
- Lab coat
- Bleach
- Water
- Paper towels

---

**IMPORTANT!** This procedure does not guarantee total decontamination of the Ion OneTouch™ ES.

---

### Decontaminate the instrument

Wear disposable rubber gloves, safety glasses, and a lab coat.

1. Wipe all outside surfaces of the Ion OneTouch™ ES with 10% bleach solution. Avoid getting bleach solution inside the chassis.
2. Dry the surfaces of the Ion OneTouch™ ES with paper towels or other disposable wipes.
3. Use cotton swabs to clean and dry areas that are difficult to reach.
4. Properly dispose of used cleaning materials.



# Supplemental procedures

- Unpack and install the Ion OneTouch™ 2 System ..... 96
- Install a firmware update ..... 98
- Initialize the Ion OneTouch™ 2 Instrument ..... 101
- Download the log files from the Ion OneTouch™ 2 Instrument ..... 109
- Ion OneTouch™ 2 Instrument touchscreen messages ..... 110
- Decontaminate the Ion OneTouch™ 2 Instrument ..... 111

## Unpack and install the Ion OneTouch™ 2 System

For detailed instructions on site preparation and installation of the Ion OneTouch™ 2 Instrument and Ion OneTouch™ ES Instrument, refer to:

- Site preparation and installation requirements: *Ion Personal Genome Machine™ System Site Preparation Guide for use with the Ion Personal Genome Machine™ Sequencer, Ion Torrent™ Server, and Ion OneTouch™ 2 System* (Pub. no. MAN0007516).
- Unpacking and installation instructions: See the following topics "Unpack and install the Ion OneTouch™ 2 Instrument", and "Unpack and install the Ion OneTouch™ ES".

### Unpack and install the Ion OneTouch™ 2 Instrument

1. Unpack and install the Ion OneTouch™ 2 Instrument in a location different from the location used to prepare the amplification solution. Refer to the *Unpack and Install the Ion OneTouch™ 2 System Product Insert* (Pub. no. 4481875) and the *Ion Personal Genome Machine™ System Site Preparation Guide for use with the Ion Personal Genome Machine™ Sequencer, Ion Torrent™ Server, and Ion OneTouch™ 2 System*. Remove the instrument by laying the shipping box sideways on a table, then sliding out the instrument.

---

**IMPORTANT!** Do not lift the instrument by the metal handle used to access the Ion OneTouch™ 2 Amplification Plate.

---

2. Ensure that the power switch is turned OFF, then plug the power cord into the instrument.
3. Plug the other end of the power cord into an electrical outlet of the appropriate voltage.

---

**IMPORTANT!** The Ion OneTouch™ 2 Instrument draws 6 amps of current. Do not exceed the circuit breaker limit for current. If necessary, plug multiple instruments into different circuits.

---





4. Turn the power switch ON. Initial start-up takes ~3 minutes. You may hear sounds from the instrument. This is normal.

---

**IMPORTANT!** Leave ON the Ion OneTouch™ 2 Instrument. If the instrument is turned off, critical log files are lost. If you need to turn OFF the instrument or if a run fails, download the log files (see “Download the log files from the Ion OneTouch™ 2 Instrument” on page 109).

---

## Unpack and install the Ion OneTouch™ ES

1. Unpack and install the Ion OneTouch™ ES Instrument in a location different from the location used to prepare the amplification solution.

---

**IMPORTANT!** Do *not* lift the instrument by holding the syringe located at the back of the instrument.

---

2. Install the AC line voltage fuse module (refer to the *Unpack and Install the Ion OneTouch™ 2 System Product Insert*, Pub. no. 4481875).
3. Ensure that the power switch is OFF, then plug the power cord into the instrument.
4. Plug the other end of the power cord into the surge protector or line conditioner.
5. Plug the surge protector or line conditioner into an electrical outlet.

---

**IMPORTANT!** The voltage of the electrical outlet must match the voltage of the surge protector and the selected voltage of the installed AC line voltage fuse module in the Ion OneTouch™ ES.

---

6. Ensure that the Ion OneTouch™ ES is in a room at an operating temperature of 15°C to 25°C (60°F to 77°F).
7. Turn the power switch ON.
8. Set up the Ion OneTouch™ ES, then perform the residual volume test (see “Perform a residual volume test” on page 83).  
**Note:** Leave ON the Ion OneTouch™ ES.
9. Set up and run the Ion OneTouch™ 2 System.

## Install a firmware update

### Install a firmware update with a USB flash drive

---

**IMPORTANT!** Reformatting the USB flash drive erases data on the drive.

---

1. Ensure that the USB flash drive is FAT32-formatted:

Operating system	Procedure...
Mac OS™	<ol style="list-style-type: none"> <li>1. Insert the USB flash drive into a USB port, then double-click the <b>Macintosh HDD</b> icon.</li> <li>2. Navigate to the <b>Applications</b> folder, then click: <b>Utilities ▶ Disk Utility</b>.</li> <li>3. Double-click the <b>Disk Utility</b> application.</li> <li>4. Select the drive (the <i>USB flash drive</i>) to format, then click <b>Erase</b>.</li> <li>5. From the volume format, select <b>MS-DOS (FAT)</b>, then enter a name for the USB flash drive.</li> <li>6. Click <b>Erase</b>, then confirm the FAT32 formatting.</li> </ol>
Windows™	<ol style="list-style-type: none"> <li>1. Insert the USB flash drive into a USB port, then double-click <b>My Computer</b>.</li> <li>2. Right-click the USB flash drive icon, then select <b>Format</b>.</li> <li>3. Select <b>FAT32</b> from the drop-down menu, click <b>Start</b>, then confirm the FAT32 formatting.</li> </ol>

2. Log in to the Torrent Browser with your ionadmin account username and password.
3. Click the Settings icon at top-right of the screen, then select **Configure** from the drop-down menu.
4. Click **Admin Interface ▶ Update OneTouch Device** then download the appropriate update file (.bz2) to your formatted USB flash drive.
5. On the Ion OneTouch™ 2 Instrument, turn the power switch ON.

6. Ensure that the instrument is not performing a run and that the home screen displays:

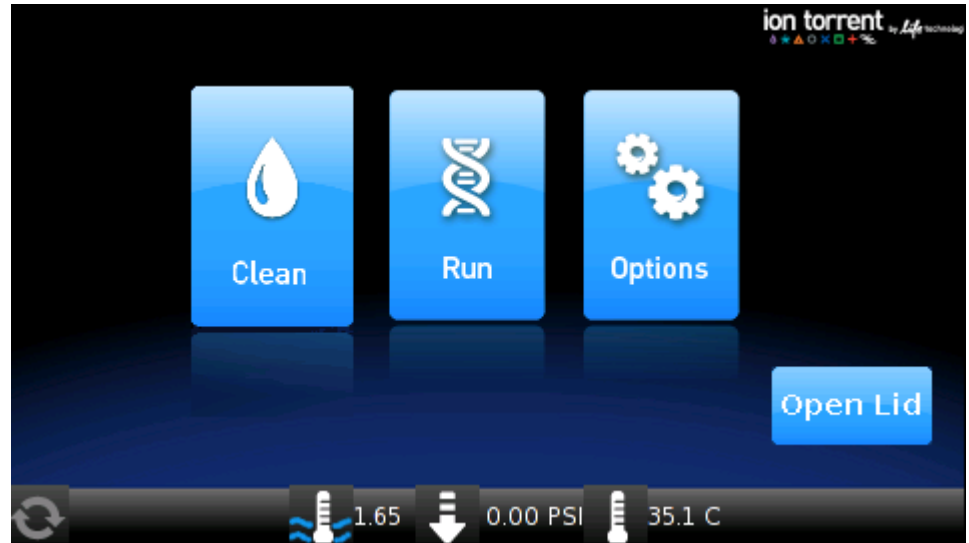

7. On the home screen, touch **Options** ▶ **Upgrade**:



8. Insert the USB flash drive into the USB port, located on the back of the Ion OneTouch™ 2 Instrument:

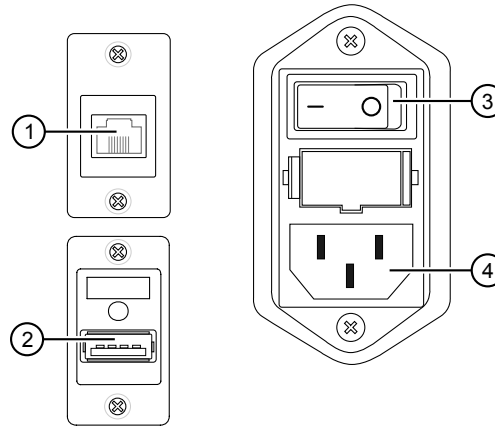

- ① Ethernet connection
- ② USB port
- ③ Power switch (on/off)
- ④ Power socket

9. On the Upgrade screen, touch **Yes**. If you touch **No**, the Options screen displays.
10. Wait 10 seconds for the screen to display the software status update:
  - If the status update displays, proceed to step 9.
  - If the Options screen displays, then there are no firmware updates.
11. Touch **Options** ▶ **Info** to ensure that the new version of the firmware update is installed.
12. Turn the power switch OFF, wait several seconds, then remove the USB flash drive.
13. Turn the power switch ON.

### Alternative method: Install a firmware update using an Ethernet connection

**Note:** Use a shielded Category 6 Ethernet cable to connect to the Ion OneTouch™ 2 Instrument.

1. Turn the power switch OFF.
2. Connect the Ion OneTouch™ 2 Instrument to the Torrent Server via a Category 6 Ethernet cable.
3. Turn the power switch ON. Initial start-up takes ~3 minutes.

**Note:** You may hear sounds from the instrument. This is normal.

4. Log in to the Torrent Browser with your ionadmin account username and password.
5. Click the Settings icon at top-right of the screen, then select **Configure** from the drop-down menu.

- Click **Admin Interface** ▶ **Update OneTouch Device** ▶ **Update** then wait for the update to complete and the instrument to reset.

**Note:** A progress bar appears on the instrument during the update.

- Touch **Options** on the Ion OneTouch™ 2 Instrument home page to ensure that the new version of the firmware update is installed.



## Initialize the Ion OneTouch™ 2 Instrument

### Set up the Ion OneTouch™ 2 Instrument

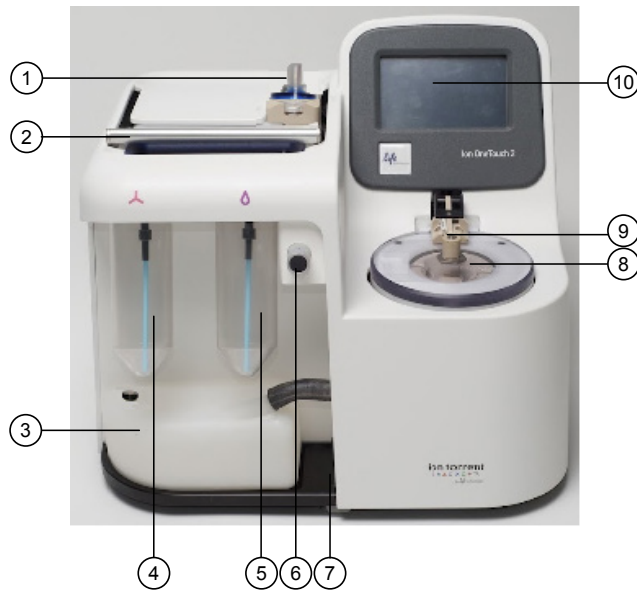
Before operating the Ion OneTouch™ 2 Instrument for the first time, you must perform the one-time initialization on the instrument. Initialization primes the pumps and tubing lines for reliable operation. Perform initialization at any time before the first run.



#### Ion OneTouch™ 2 Instrument layout

- |  |   |
|--|---|
| ① Ion PGM™ OneTouch Plus Reaction Filter Assembly  | ⑥ Pinch valve to hold disposable tubing                     |
| ② Clamp handle to access the Amplification Plate in the heat block   | ⑦ Oil waste tray  |
| ③ Waste Container  | ⑧ Centrifuge to spin the Recovery Tubes and Recovery Router |
| ④ Ion OneTouch™ Oil               | ⑨ Ion OneTouch™ DL Injector Hub                             |
| ⑤ Ion PGM™ OT2 Recovery Solution  | ⑩ Instrument display  |

## Materials required for this procedure

### Provided in Ion PGM™ Template OT2 Supplies 200 Kit (Part no. 4480981):

- 2 Ion OneTouch™ Reagent Tubes
- Ion OneTouch™ Recovery Router
- 2 Ion OneTouch™ Recovery Tubes
- Ion OneTouch™ 2 Amplification Plate
- 2 Ion OneTouch™ Sipper Tubes

### Provided in Ion PGM™ Template OT2 Solutions 200 Kit (Part no. 4481105):

- Ion OneTouch™ Oil
- Ion PGM™ OT2 Recovery Solution

**Note:** This protocol has been verified using only the material specified. Substitution may adversely affect performance and safety.

---

**IMPORTANT!** Use *only* the Ion PGM™ Template OT2 200 Kit (Cat. no. 4480974) with this user guide and with the Ion OneTouch™ 2 Instrument. Do not use the kit with the Ion OneTouch™ System. Do *not* mix reactions or disposables including plates, solutions, and kit reagents from other template preparation kits.

---

## Install the Ion OneTouch™ Recovery Tubes and Ion OneTouch™ Recovery Router

1. On the instrument touchscreen, touch **Open Lid**, wait until the lid clicks open, then lift and hold the side of the centrifuge lid.

**IMPORTANT!** Do *not* lift the lid by the tubing attached to the Ion OneTouch™ DL Injector Hub.

---

2. Insert an Ion OneTouch™ Recovery Tube into each slot in the centrifuge.

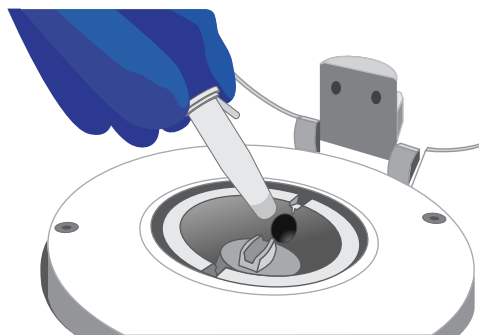

3. Pinch the sides of the Ion OneTouch™ Recovery Router then push the router down into the center slot of the centrifuge so that the router is seated flat and secure in the center of the rotor:

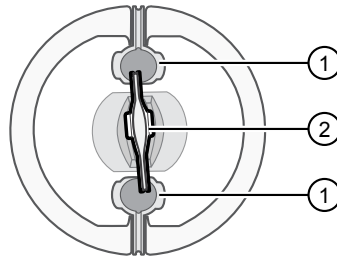

- ① Ion OneTouch™ Recovery Tube
- ② Ion OneTouch™ Recovery Router

**Note:** The Recovery Router is intentionally offset from the Recovery Tubes.

4. Close the centrifuge lid.

### Install the Ion OneTouch™ 2 Amplification Plate

1. If there is a used Ion OneTouch™ 2 Cleaning Adapter on the instrument, remove and appropriately discard it.

**Note:** The Cleaning Adapter may be filled with Ion OneTouch™ Oil.

2. Push the handle back to open the heat block.



**CAUTION! Hot Surface.** Use care when working around this area to avoid being burned by hot components.

---



**WARNING! Safety Hazard.** Do not use the instrument with flammable or explosive materials. Use only the materials specified for use with the instrument to ensure safety.

---

3. Insert the Amplification Plate:
  - a. Inspect the Ion OneTouch™ 2 Amplification Plate to ensure the plate port is straight and perpendicular to the plate.

**IMPORTANT!** The disposable tubing and disposable injector are attached to the Amplification Plate. Do *not* disconnect tubing from the top plate port. If you have questions about the plate, contact Technical Support.

---

- b. Hold the disposable injector, connected to the disposable tubing, in one hand and the Amplification Plate in the other hand.



**CAUTION! PHYSICAL INJURY HAZARD.** The pointed end of the disposable injector can puncture your skin. Keep your hand away from the point of the disposable injector.

---

- c. Insert the Amplification Plate into the heat block so that the single plate port aligns with the *left* hole of the Ion OneTouch™ 2 Instrument:

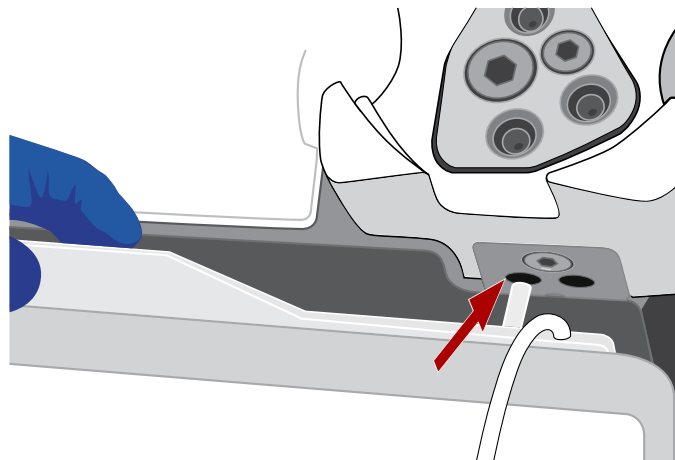

4. Pull the heat block handle forward to close the block, then thread the disposable tubing through the Ion OneTouch™ DL Tubing Catch:

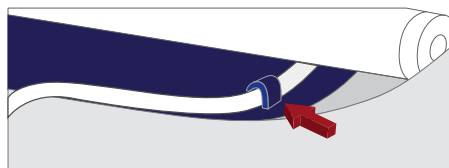

**Note:** The disposable tubing is under the handle.

5. Install the disposable tubing in the pinch valve:
- Align the disposable tubing with the slot that runs along the bottom of the pinch valve.
  - Gently pull the disposable tubing upwards on the both sides of the pinch valve until the disposable tubing is in the slot (see below) and secured in the round notch on each side of the pinch valve:

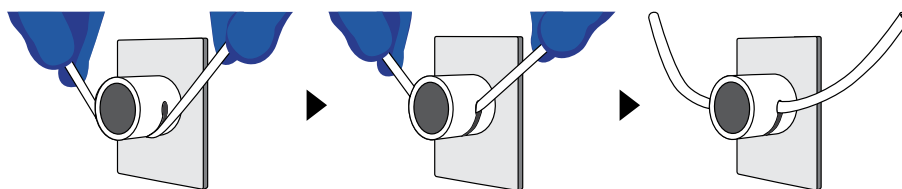

- c. If necessary, adjust the disposable tubing along the notches of the open pinch valve so that there is sufficient length of disposable tubing to install the disposable injector (see “Install the disposable injector” on page 105).



### Install the disposable injector

**Note:** The long metal shaft of the disposable injector may be slightly bent, which is normal. If you have questions about the disposable injector, contact Technical Support.

1. Place one hand on the centrifuge lid and insert the disposable injector straight into the port of the Ion OneTouch™ DL Injector Hub. Push the injector through the port until it just stops at the base of the router:



**CAUTION! PHYSICAL INJURY HAZARD.** The pointed end of the injector can puncture your skin. Keep your hand away from the point of the injector.

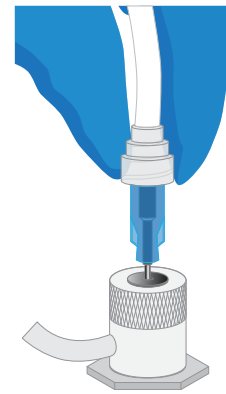

**Note:** The color of the injector may vary.

2. Confirm automatic placement of the injector above the router. Briefly press then release the spring-loaded top of the Injector Hub. You should hear a click:

**Up position**

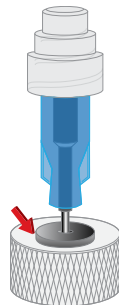

**Down position**

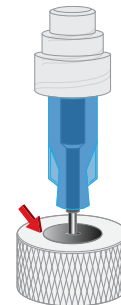

---

**IMPORTANT!** If the Injector Hub remains in the down position, see Appendix A, “Troubleshooting”.

---

**IMPORTANT!** If you raise the centrifuge lid, do not hit the injector against the instrument. If you damage the disposable injector, appropriately dispose of the injector, amplification plate, and tubing. Use a new injector and Ion OneTouch™ 2 Amplification Plate.

---

### Install the Ion OneTouch™ Oil

1. Fill a new Ion OneTouch™ Reagent Tube with Ion OneTouch™ Oil on the *left* front port 
  - a. Use fresh gloves to attach the Luer-Lok™ end of a new Ion OneTouch™ Sipper Tube to the *left* front port. Do **not** let the Sipper Tube touch any surface.
  - b. Invert the on Ion OneTouch™ Oil bottle (450-mL size) 3 times to mix, then fill a new Reagent Tube half-full with oil. Minimize bubbles.
2. Insert the filled Reagent Tube into the left front port, and screw the tube firmly into place, one-quarter turn on the instrument.

### Install the Ion PGM™ OT2 Recovery Solution

---

**IMPORTANT!** Use only the Ion PGM™ OT2 Recovery Solution in the Ion OneTouch™ kit that you are currently using. Do **not** use a different recovery solution from another kit.

---

1. Inspect the Recovery Solution. If the solution is not clear, heat the bottle in a 30°C bath until the solution is clear.
2. Fill a new Ion OneTouch™ Reagent Tube with Ion PGM™ OT2 Recovery Solution and install it on the right front port 
  - a. Use fresh gloves to attach the Luer-Lok™ end of a new Ion OneTouch™ Sipper Tube to the right front port. Do **not** let the Sipper Tube touch any surfaces. Minimize bubbles.
  - b. Invert the Recovery Solution bottle 3 times, then fill the Reagent Tube a quarter-full with solution.
3. Insert the filled Reagent Tube into the right front port, and screw the tube firmly into place, one-quarter turn on the instrument.

### Install the Ion OneTouch™ 2 Cleaning Adapter

Note the orientation of the ports and tabs on the Ion OneTouch™ 2 Cleaning Adapter:

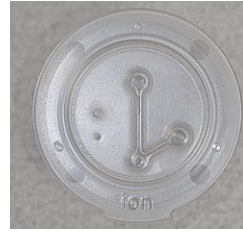

Firmly insert the 3 ports of the Cleaning Adapter into the three holes on the top stage of the Ion OneTouch™ 2 Instrument. The tab protruding from the outer edge of the Cleaning Adapter fits into the front notch of the stage:

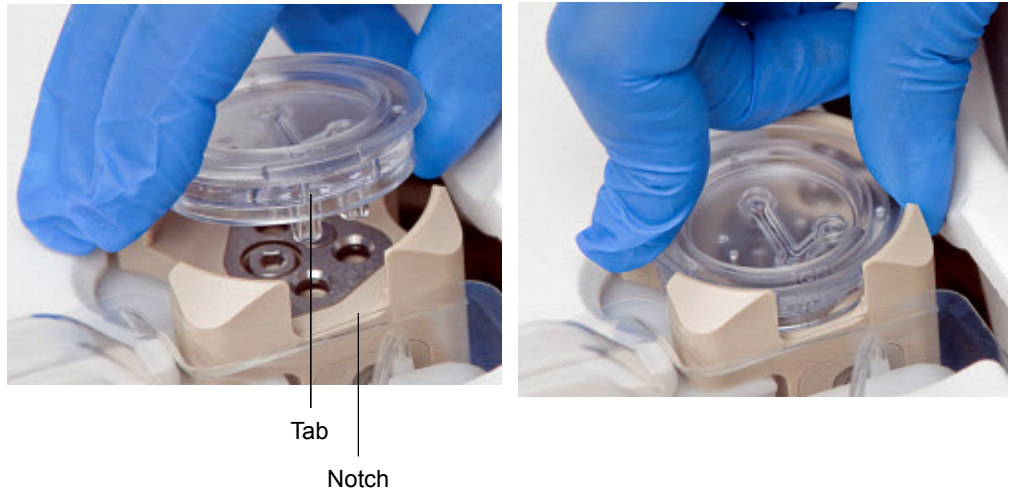

## Initialize the instrument

1. On the home screen, touch **Options**:

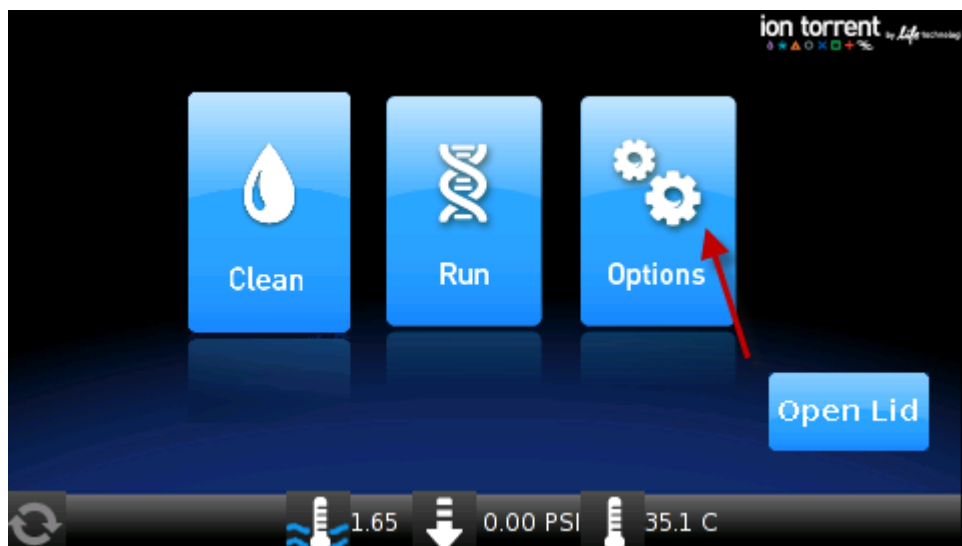

2. Touch **Initialize**:

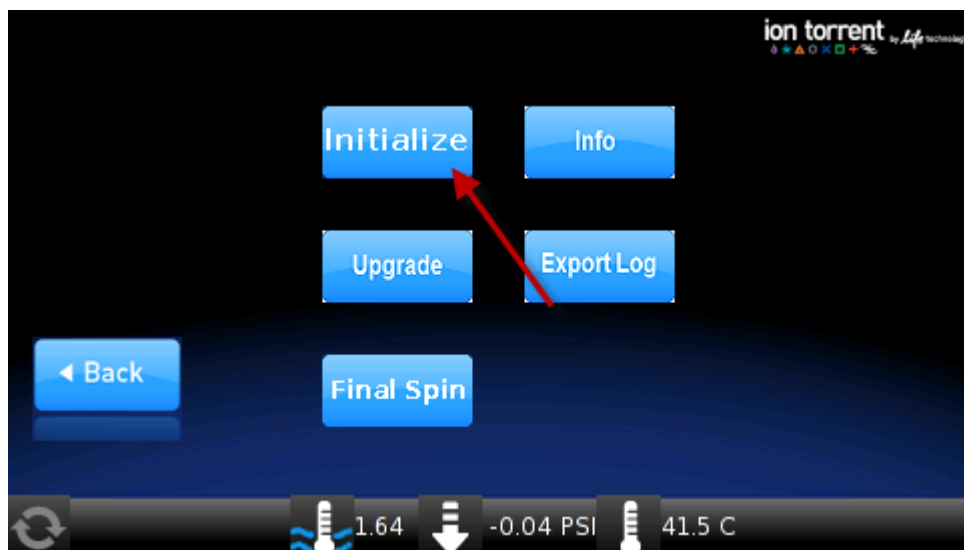

Initialization takes 10 minutes.

## Continue to set up the Ion OneTouch™ 2 Instrument

1. Remove and retain the Ion OneTouch™ 2 Cleaning Adapter. You can reuse the Cleaning Adapter one time for the instrument maintenance protocol after the first run, but you must appropriately dispose of the used Cleaning Adapter after maintenance (see “Maintain the Ion OneTouch™ 2 Instrument” on page 38).
2. Keep all of the disposable components that were used for initialization in place, including the Ion OneTouch™ 2 Amplification Plate, disposable line, disposable injector, Ion OneTouch™ Router, and Ion OneTouch™ Recovery Tubes.

---

**IMPORTANT!** After the first run on the Ion OneTouch™ 2 Instrument, appropriately dispose of all components as directed.

---

3. Complete the remaining tasks to set up for a sample run (see “Perform a verification run” on page 16).

## Download the log files from the Ion OneTouch™ 2 Instrument

Log files capture important information regarding instrument operation and may be used to troubleshoot the instrument.

---

**IMPORTANT!** Log files are automatically deleted from the instrument when the instrument is turned off. To preserve the log files, leave the instrument on until you can download them.

---

1. Ensure that the Ion OneTouch™ 2 Instrument is not performing a run.
2. Format a USB flash drive, if necessary (see “Install a firmware update with a USB flash drive” on page 98). Confirm that a formatted USB flash drive has no data files on it.
3. Insert the USB flash drive into the USB port, located on the back of the Ion OneTouch™ 2 Instrument:

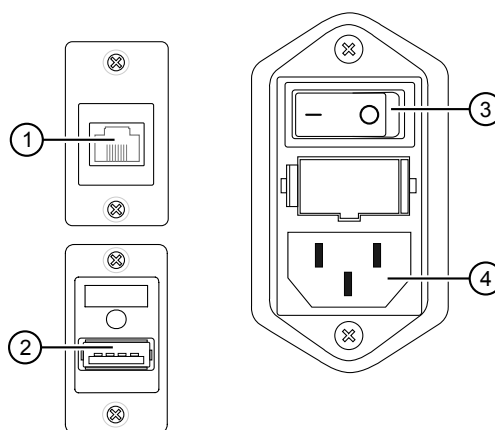

- |                       |                         |
|-----------------------|-------------------------|
| ① Ethernet connection | ③ Power switch (on/off) |
| ② USB port            | ④ Power socket          |

4. In the home screen, touch **Options**, then touch **Export Log**:

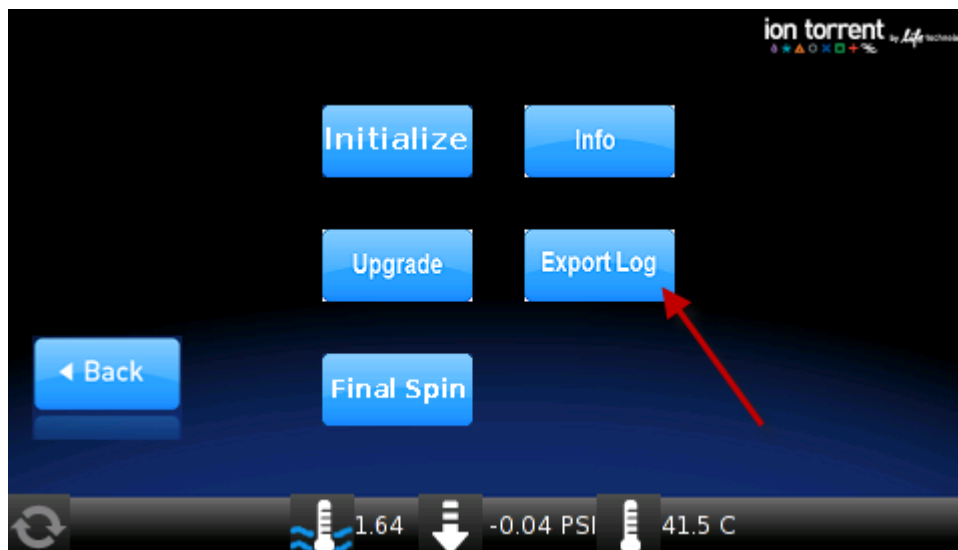

5. In the Export log screen, touch **Yes**. The log files export to the USB flash drive and the status update displays. After export, the Options screen displays.
6. Remove the USB flash drive from the instrument, then verify on a computer that the instrument downloaded the log files to the flash drive. If the files are:
  - Downloaded: Proceed to the next step.
  - Not downloaded: Repeat steps 3–6 until the log files are downloaded.
7. Save the log files to a computer.

## Ion OneTouch™ 2 Instrument touchscreen messages

If the on-screen message is...	Then the instrument is...
Priming and Filling Recovery Solution	Priming the filter and filling the collection tubes with Ion PGM™ OT2 Recovery Solution.
Sample Injection	Injecting sample and starting emulsification.
Amplification	Amplifying the sample by PCR.
Filling Recovery Solution	Completely filling the Ion OneTouch™ Recovery Tubes with Ion PGM™ OT2 Recovery Solution.
ISP Collection	Breaking the emulsion and collecting the Ion Sphere™ Particles (ISPs).
Wash Cycles	Washing the instrument and draining the washes.
Final Spin	Performing final centrifugation to pellet the ISPs in the Ion OneTouch™ Recovery Tubes.



## Decontaminate the Ion OneTouch™ 2 Instrument

Before returning the instrument for service, decontaminate it according to the procedure below.

### Materials and equipment required

- Disposable rubber gloves
- Safety glasses
- Lab coat
- Bleach
- Water
- Paper towels

---

**IMPORTANT!** This procedure does not guarantee total decontamination of the Ion OneTouch™ 2 Instrument.

---

### Decontaminate the instrument

1. Wear disposable rubber gloves, safety glasses, and a lab coat.
2. Use a cleaning pad wetted with a solution of 1 part chlorine bleach in 9 parts water (10% bleach solution) to clean all outside surfaces of the Ion OneTouch™ 2 Instrument. Use care to avoid getting bleach solution inside the chassis.
3. Dry the surfaces of the Ion OneTouch™ 2 Instrument with paper towels or other disposable wipes.
4. Use cotton swabs to clean and dry areas that are difficult to reach.
5. Properly dispose of used cleaning materials to ensure that no one becomes exposed to contaminants.







# Safety

- 
-  **WARNING! GENERAL SAFETY.** Using this product in a manner not specified in the user documentation may result in personal injury or damage to the instrument or device. Ensure that anyone using this product has received instructions in general safety practices for laboratories and the safety information provided in this document.
- Before using an instrument or device, read and understand the safety information provided in the user documentation provided by the manufacturer of the instrument or device.
  - Before handling chemicals, read and understand all applicable Safety Data Sheets (SDSs) and use appropriate personal protective equipment (gloves, gowns, eye protection, etc). To obtain SDSs, see the “Documentation and Support” section in this document.
- 





## Symbols on this instrument

Symbols may be found on the instrument to warn against potential hazards or convey important safety information. In this document, the hazard symbol is used along with one of the following user attention words:

- **CAUTION!** – Indicates a potentially hazardous situation that, if not avoided, may result in minor or moderate injury. It may also be used to alert against unsafe practices.
- **WARNING!** – Indicates a potentially hazardous situation that, if not avoided, could result in death or serious injury.
- **DANGER!** – Indicates an imminently hazardous situation that, if not avoided, will result in death or serious injury.

Symbol	English	Français
	Caution, risk of danger Consult the manual for further safety information.	Attention, risque de danger Consulter le manuel pour d'autres renseignements de sécurité.
	Moving parts	Parties mobiles
	Caution, hot surface	Attention, surface chaude
	On/Off	On/Off (marche/arrêt)



Symbol	English	Français
	Protective conductor terminal (main ground)	Borne de conducteur de protection (mise à la terre principale)
	Do not dispose of this product in unsorted municipal waste   <b>CAUTION!</b> To minimize negative environmental impact from disposal of electronic waste, do not dispose of electronic waste in unsorted municipal waste. Follow local municipal waste ordinances for proper disposal provision and contact customer service for information about responsible disposal options.	Ne pas éliminer ce produit avec les déchets usuels non soumis au tri sélectif.   <b>CAUTION!</b> Pour minimiser les conséquences négatives sur l'environnement à la suite de l'élimination de déchets électroniques, ne pas éliminer ce déchet électronique avec les déchets usuels non soumis au tri sélectif. Se conformer aux ordonnances locales sur les déchets municipaux pour les dispositions d'élimination et communiquer avec le service à la clientèle pour des renseignements sur les options d'élimination responsable.

## Instrument safety

### General

---

 **CAUTION! Do not remove instrument protective covers.** If you remove the protective instrument panels or disable interlock devices, you may be exposed to serious hazards including, but not limited to, severe electrical shock, laser exposure, crushing, or chemical exposure.

---

### Physical injury

---

 **CAUTION! Moving Parts.** Moving parts can crush, pinch and cut. Keep hands clear of moving parts while operating the instrument. Disconnect power before servicing.

---

## Electrical



**WARNING! Ensure appropriate electrical supply.** For safe operation of the instrument:

- Plug the system into a properly grounded receptacle with adequate current capacity.
  - Ensure the electrical supply is of suitable voltage.
  - Never operate the instrument with the ground disconnected. Grounding continuity is required for safe operation of the instrument.
- 



**WARNING! Power Supply Line Cords.** Use properly configured and approved line cords for the power supply in your facility.

---



**WARNING! Disconnecting Power.** To fully disconnect power either detach or unplug the power cord, positioning the instrument such that the power cord is accessible.

---

## Cleaning and decontamination



**CAUTION! Cleaning and Decontamination.** Use only the cleaning and decontamination methods specified in the manufacturer's user documentation. It is the responsibility of the operator (or other responsible person) to ensure the following requirements are met:

- No decontamination or cleaning agents are used that could cause a HAZARD as a result of a reaction with parts of the equipment or with material contained in the equipment.
  - The instrument is properly decontaminated a) if hazardous material is spilled onto or into the equipment, and/or b) prior to having the instrument serviced at your facility or sending the instrument for repair, maintenance, trade-in, disposal, or termination of a loan (decontamination forms may be requested from customer service).
  - Before using any cleaning or decontamination methods (except those recommended by the manufacturer), users should confirm with the manufacturer that the proposed method will not damage the equipment.
-



## Safety and electromagnetic compatibility (EMC) standards

The instrument design and manufacture complies with the standards and requirements for safety and electromagnetic compatibility as noted in the following table:

### Safety

Reference	Description
EU Directive 2006/95/EC	European Union "Low Voltage Directive"
IEC 61010-1 EN 61010-1 UL 61010-1 CSA C22.2 No. 61010-1	<i>Safety requirements for electrical equipment for measurement, control, and laboratory use – Part 1: General requirements</i>
IEC 61010-2-010 EN 61010-2-010	<i>Safety requirements for electrical equipment for measurement, control and laboratory use – Part 2-010: Particular requirements for laboratory equipment for the heating of materials</i>
IEC/EN 61010-2-020	<i>Safety requirements for electrical equipment for measurement, control and laboratory use – Part 2-020: Particular requirements for laboratory centrifuges</i>
IEC 61010-2-081 EN 61010-2-081	<i>Safety requirements for electrical equipment for measurement, control and laboratory use – Part 2-081: Particular requirements for automatic and semi-automatic laboratory equipment for analysis and other purposes</i>

### EMC

Reference	Description
Directive 2004/108/EC	European Union "EMC Directive"
EN 61326-1	<i>Electrical Equipment for Measurement, Control and Laboratory Use – EMC Requirements – Part 1: General Requirements</i>
FCC Part 18 (47 CFR)	U.S. Standard "Industrial, Scientific, and Medical Equipment"
AS/NZS 2064	<i>Limits and Methods of Measurement of Electromagnetic Disturbance Characteristics of Industrial, Scientific, and Medical (ISM) Radiofrequency Equipment</i>
ICES-001, Issue 3	<i>Industrial, Scientific and Medical (ISM) Radio Frequency Generators</i>

### Environmental design

Reference	Description
Directive 2012/19/EU	European Union "WEEE Directive" – Waste electrical and electronic equipment

## Chemical safety

---



**WARNING! GENERAL CHEMICAL HANDLING.** To minimize hazards, ensure laboratory personnel read and practice the general safety guidelines for chemical usage, storage, and waste provided below, and consult the relevant SDS for specific precautions and instructions:

- Read and understand the Safety Data Sheets (SDSs) provided by the chemical manufacturer before you store, handle, or work with any chemicals or hazardous materials. To obtain SDSs, see the “Documentation and Support” section in this document.
  - Minimize contact with chemicals. Wear appropriate personal protective equipment when handling chemicals (for example, safety glasses, gloves, or protective clothing).
  - Minimize the inhalation of chemicals. Do not leave chemical containers open. Use only with adequate ventilation (for example, fume hood).
  - Check regularly for chemical leaks or spills. If a leak or spill occurs, follow the manufacturer's cleanup procedures as recommended in the SDS.
  - Handle chemical wastes in a fume hood.
  - Ensure use of primary and secondary waste containers. (A primary waste container holds the immediate waste. A secondary container contains spills or leaks from the primary container. Both containers must be compatible with the waste material and meet federal, state, and local requirements for container storage.)
  - After emptying a waste container, seal it with the cap provided.
  - Characterize (by analysis if necessary) the waste generated by the particular applications, reagents, and substrates used in your laboratory.
  - Ensure that the waste is stored, transferred, transported, and disposed of according to all local, state/provincial, and/or national regulations.
  - **IMPORTANT!** Radioactive or biohazardous materials may require special handling, and disposal limitations may apply.
-

## Biological hazard safety



**WARNING! BIOHAZARD.** Biological samples such as tissues, body fluids, infectious agents, and blood of humans and other animals have the potential to transmit infectious diseases. All work should be conducted in properly equipped facilities using the appropriate safety equipment (for example, physical containment devices). Safety equipment also may include items for personal protection, such as gloves, coats, gowns, shoe covers, boots, respirators, face shields, safety glasses, or goggles. Individuals should be trained according to applicable regulatory and company/ institution requirements before working with potentially biohazardous materials. Follow all applicable local, state/provincial, and/or national regulations. The following references provide general guidelines when handling biological samples in laboratory environment.

- U.S. Department of Health and Human Services, *Biosafety in Microbiological and Biomedical Laboratories (BMBL)*, 5th Edition, HHS Publication No. (CDC) 21-1112, Revised December 2009; found at:  
[www.cdc.gov/biosafety/publications/bmb15/BMBL.pdf](http://www.cdc.gov/biosafety/publications/bmb15/BMBL.pdf)
  - World Health Organization, *Laboratory Biosafety Manual*, 3rd Edition, WHO/CDS/CSR/LYO/2004.11; found at:  
[www.who.int/csr/resources/publications/biosafety/Biosafety7.pdf](http://www.who.int/csr/resources/publications/biosafety/Biosafety7.pdf)
-

# Documentation and support

## Customer and technical support

Visit [thermofisher.com/support](http://thermofisher.com/support) for the latest in services and support, including:

- Worldwide contact telephone numbers
- Product support, including:
  - Product FAQs
  - Software, patches, and updates
- Order and web support
- Product documentation, including:
  - User guides, manuals, and protocols
  - Certificates of Analysis
  - Safety Data Sheets (SDSs; also known as MSDSs)

**Note:** For SDSs for reagents and chemicals from other manufacturers, contact the manufacturer.

## Limited product warranty

Life Technologies Corporation and/or its affiliate(s) warrant their products as set forth in the Life Technologies' General Terms and Conditions of Sale found on Life Technologies' website at [www.thermofisher.com/us/en/home/global/terms-and-conditions.html](http://www.thermofisher.com/us/en/home/global/terms-and-conditions.html). If you have any questions, please contact Life Technologies at [www.thermofisher.com/support](http://www.thermofisher.com/support).

For support visit [thermofisher.com/support](http://thermofisher.com/support) or email [techsupport@lifetech.com](mailto:techsupport@lifetech.com)  
thermofisher.com

19 November 2015

**ThermoFisher**  
SCIENTIFIC